

PHILOSOPHY AND THE TREE OF LIFE

THE METAPHYSICS AND EPISTEMOLOGY OF PHYLOGENETIC SYSTEMATICS

Joel D. Velasco

PHILOSOPHY AND THE TREE OF LIFE:
THE METAPHYSICS AND EPISTEMOLOGY
OF PHYLOGENETIC SYSTEMATICS

by

Joel D. Velasco

A dissertation submitted in partial fulfillment of
the requirements for the degree of

Doctor of Philosophy

(Philosophy)

at the

UNIVERSITY OF WISCONSIN-MADISON

2008

© Copyright by Joel Velasco 2008

All Rights Reserved

Abstract:

This dissertation examines the foundations of phylogenetic systematics which involves both the construction of phylogenetic trees to represent evolutionary history and the use of those trees to study various aspects of that history. I begin by defending a genealogy-based view of biological taxonomy: the view that all taxa—the formal groups in our classification system—must be monophyletic, i.e., they must consist of an ancestor and all of its descendants. Furthermore, I argue that, contrary to current practice, these taxa should not be assigned ranks (such as genus, family, and order).

I then proceed by applying these principles to the debate about species. I argue that non-genealogically based species concepts (such as the popular “biological species concept”) are unacceptable. Instead, a species concept must delimit species so that they form genealogically exclusive groups – groups of organisms more closely related to each other than to any organisms outside the group. With this in mind, I develop two distinct phylogenetic species concepts. Each treats a species as a genealogically exclusive group of organisms. The first determines genealogical relatedness in terms of recency of common ancestry; the second understands genealogy as a composite of gene histories. Finally, I argue that there can be no objective ranking criteria for species and therefore biologists can either keep the species rank, while acknowledging that which taxa are ranked as species is arbitrary, or alternatively, can simply get rid of the rank of species.

Having carefully described what phylogenies represent, I move to the epistemological problem of inferring phylogenetic trees and argue that a Bayesian methodology is appropriate. I then focus on one common objection to Bayesian inference – “the problem of prior probabilities.” I argue that this problem has been misunderstood in some cases, which leads to the failure of a variety of objections in the literature. I then develop the beginnings of a solution to this problem within phylogenetics, describe just what has been achieved, and acknowledge what has yet to be accomplished.

Acknowledgements

Thanks to my committee members Elliott Sober, Malcolm Forster, Dan Hausman, Ken Sytsma, Bret Larget and unofficial member David Baum who read the entire manuscript. Elliott and David in particular provided detailed comments on multiple drafts of the entire dissertation making the final version far better than it would have otherwise been.

Thanks also to Matt Barker, Marc Ereshefsky, Matt Haber, Joe LaPorte, and Greg Novack who read portions of the thesis in article form again leading to a far better final version.

As of the completion of this dissertation (May, 2008), it incorporated text from three journal articles and a number of referees helped improve those articles and therefore this thesis. These include anonymous referees from the *British Journal of the Philosophy of Science* and *Studies in the History and Philosophy of Science* who have helped improve portions of Chapters 1 and 2. These include Mike Alfaro on behalf of *Molecular Phylogenetics and Evolution*, as well as Kim Sterelny and an anonymous referee from *Biology and Philosophy* who made very helpful suggestions for Chapter 5.

Contents

Abstract	i
Acknowledgements	ii
1 Two Principles of Phylogenetic Systematics	1
The Tree of Life	1
Phylogenetic trees	8
Why paraphyletic groups are bad	17
Ranking	22
Are ranks even consistent?	29
Why sister groups must have the same rank	31
Rank as age	35
Why classification is not important	40
Back to the Tree of Life	44
2 The Need for a Phylogenetic Species Concept	46
Introduction	46
The Biological Species Concept	48
How the BSC distorts history	50
Responses to the parapyly problem	55
The second kind of misrepresentation	58
Species and the Tree of Life	63

3	Developing a Phylogenetic Species Concept	72
	A Phylogenetic Species Concept	72
	Monophyletic groups of organisms	76
	Epistemological issues	77
	The real problem with non-nested groups	80
	From monophyly to exclusivity	82
	From organism pedigrees to gene genealogies	89
	Gene genealogies	92
	Exclusivity as recentness of genetic coalescence	98
	From 100% to less	100
	Criticisms of the genealogical species concept	104
	Organisms or genes?	112
4	Species as a Rank	114
	Species as a Rank	114
	Species as basal taxa	119
	Species as individuals	123
	Category vs. taxon	127
	Sidestepping more metaphysics	129
	An ambiguous debate	135
	Species as evolutionary units	140
	Species as a grade	142

	Getting rid of Species	147	v
	Phylogenetics without species	150	
5	Inferring Phylogenetic Trees	155	
	1 Introduction	155	
	2 Bayesian phylogenetics	157	
	Priors on clades	164	
	Possible Priors and the Principle of Indifference	172	
	The Yule Process	174	
	The Base-Rate Fallacy	181	
	<i>References</i>	185	

ONE

TWO PRINCIPLES OF PHYLOGENETIC SYSTEMATICS

1. The Tree of Life

It was, of course, Darwin who revolutionized our understanding of the diversity of life with his *On the Origin of Species* (Darwin 1859). It is in the *Origin* that we first see the importance of genealogy on a grand scale where Darwin convincingly argues that common ancestry explains both the striking similarities between different species and the groups within groups hierarchy of traits. As he says,

“All the foregoing rules and aids and difficulties in classification are explained, if I do not greatly deceive myself, on the view that the natural system is founded on descent with modification; that the characters which naturalists consider as showing true affinity between any two or more species, are those which have been inherited from a common parent, and, in so far, all true classification is genealogical; that community of descent is the hidden bond which naturalists have been unconsciously seeking, and not some unknown plan of creation, or the enunciation of general propositions, and the mere putting together and separating objects more or less alike” (420).

Earlier, Darwin had introduced the metaphor of the Tree of Life which connects all life through genealogy.

“The affinities of all the beings of the same class have sometimes been represented by a great tree. I believe this simile largely speaks the truth.....The green and budding twigs may represent existing species; and those produced during former years may represent the long succession of extinct species.....the great **Tree of Life**...covers the earth with ever-branching and beautiful ramifications.” (129-30.)

To help us understand the Tree, Darwin gives us a figure – the only figure in the entire *Origin* – which he then repeatedly refers back to (116).

Figure 1.1 Darwin's "Tree-Thinking". The only figure in *On the Origin of Species*, it represents "descent with modification".

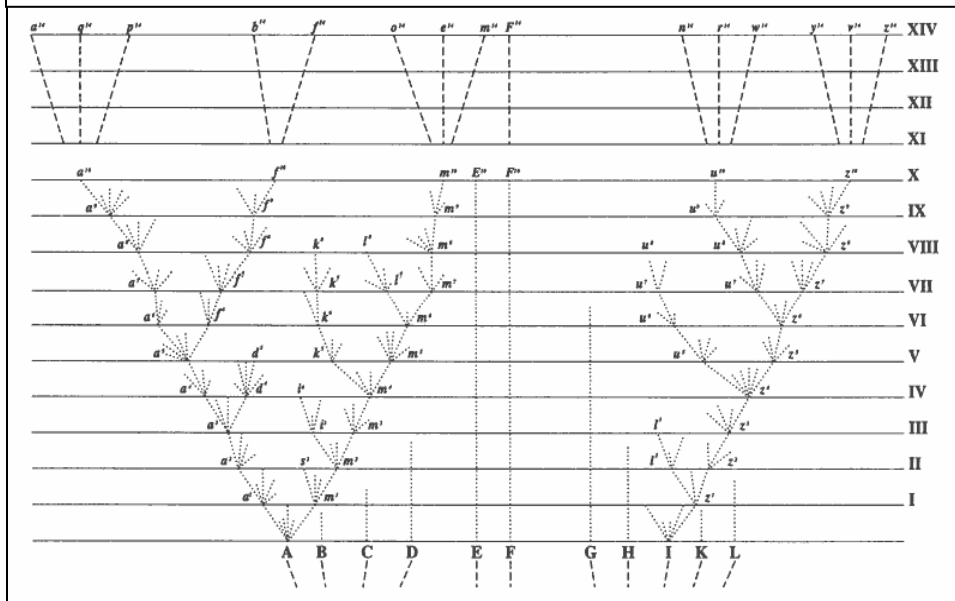

Key to understanding the diagram is that this represents real genealogical history – and not simply a subordination of groups within groups such as the diagrams previously given by Linnaeus, among others.

It is also important that Darwin did not label the Tree more specifically than he did – for example, by saying that this is how various groups of mammals are related to each other. Rather, the idea is that this same pattern is seen throughout all life. In addition, the Tree is not meant to be just a depiction of how *species* are related but rather, how *taxa* are related. A "taxon", (plural "taxa") refers to any formally named group, such as *Homo sapiens*, in our system of biological classification. Darwin refers to this same diagram in discussing the relationship of higher taxa like genera (123) (where "higher taxa" simply means any taxa more inclusive than a species) and subspecific groups like varieties (117) as well as species (120). In this manner, the figure is rather like a fractal – the same pattern emerges when we “zoom in” or “zoom out” on some particular aspect of the Tree.

Although Darwin believed that genealogy was important for classification, he did not believe that it was sufficient for providing a full classification. But for now, ignore classification and focus just on the concept of genealogy and the Tree of Life. This idea of the Tree which connects all life was prevalent in the literature for the next 100 years, but mainly served as a metaphor for evolution or even for progress. Famously, Ernst Haeckel depicted various versions of the Tree in many different works. One of his more famous figures is first seen in his 1874 work *Anthropogenie*. Figure 1.2 is from the 1876 translation of this work into English called *The Evolution of Man*.

Figure 1.2 A depiction of the Tree of Life from Ernst Haeckel (1874 and 1876) Plate XV.

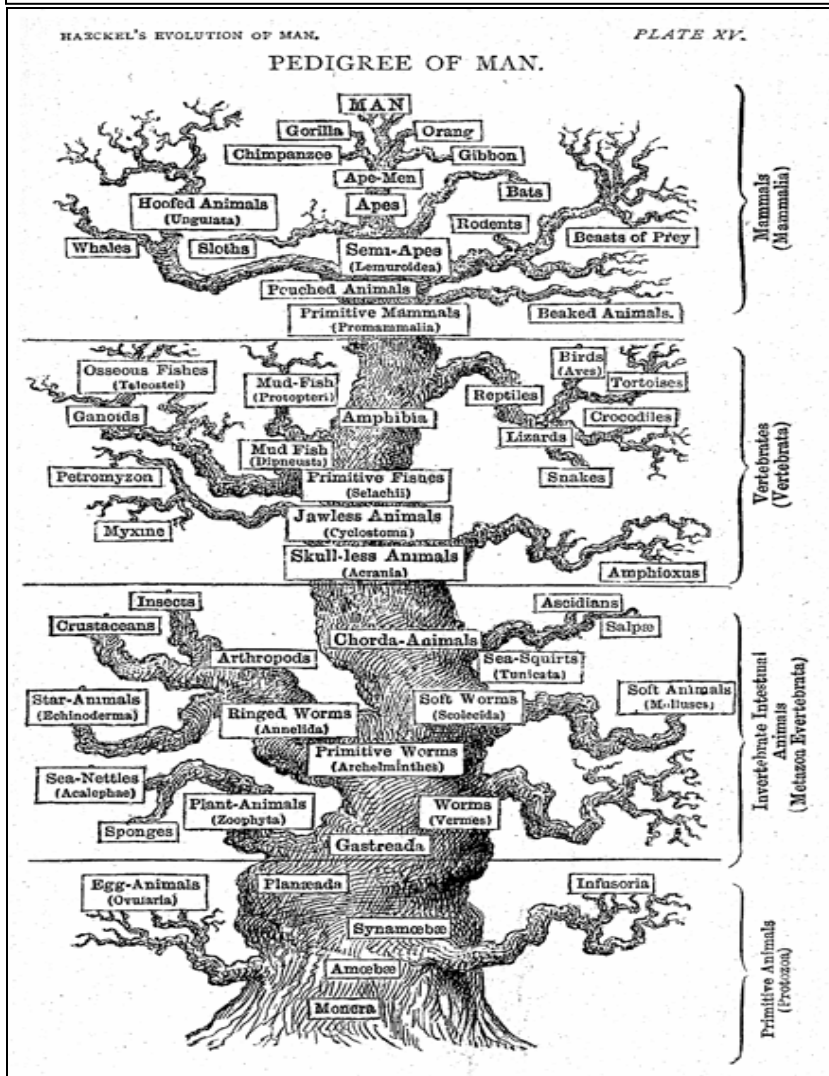

Although there is certainly some branching depicting common ancestry, the diagram is clearly still influenced by ladder thinking. Notice that humans stand at the top of the Tree while more “primitive” forms are at the base giving the impression that mammals, primates, and humans actually arose from these more primitive groups. However, these

primitive groups are not direct ancestors. Rather, they are currently existing groups! Instead of the groups sharing an ancestor/descendant relationship, currently existing groups must share common ancestry – that is, they are all the descendants of some common ancestor.

The tree is obviously anthropocentric as well with humans at the top. This smacks of a kind of progressivism – certainly popular historically (Ruse 2005) but which is unpopular today. Not only is it progressively leading to humans at the top, but there is clearly a “main” line of evolution and then various branches split off from the main line. However, what appears to be the main branch is simply a function of how it is presented. Equally correct trees can be quite jarring when the apparently "main" branch doesn't lead to humans as is the case in Figure 1.3.

Current trees may still present a bias by placing humans at the far right and given that in certain cultures we tend to read left-to-right horizontally, this gives the impression that they are “last” in the long line of evolution (Sandvik 2008). Though these trees might be psychologically misleading, they are not incorrect. If in fact they correctly portray the branching structure of every represented group, then like the butterfly tree in Figure 1.3, they are immune from the criticism that they misrepresent the phylogeny.

Figure 1.3 The evolutionary tree of the animals, especially those along the lines the evolved into butterflies. The numbers refer to millions of years ago. – This figure and caption are from Scott (1995).

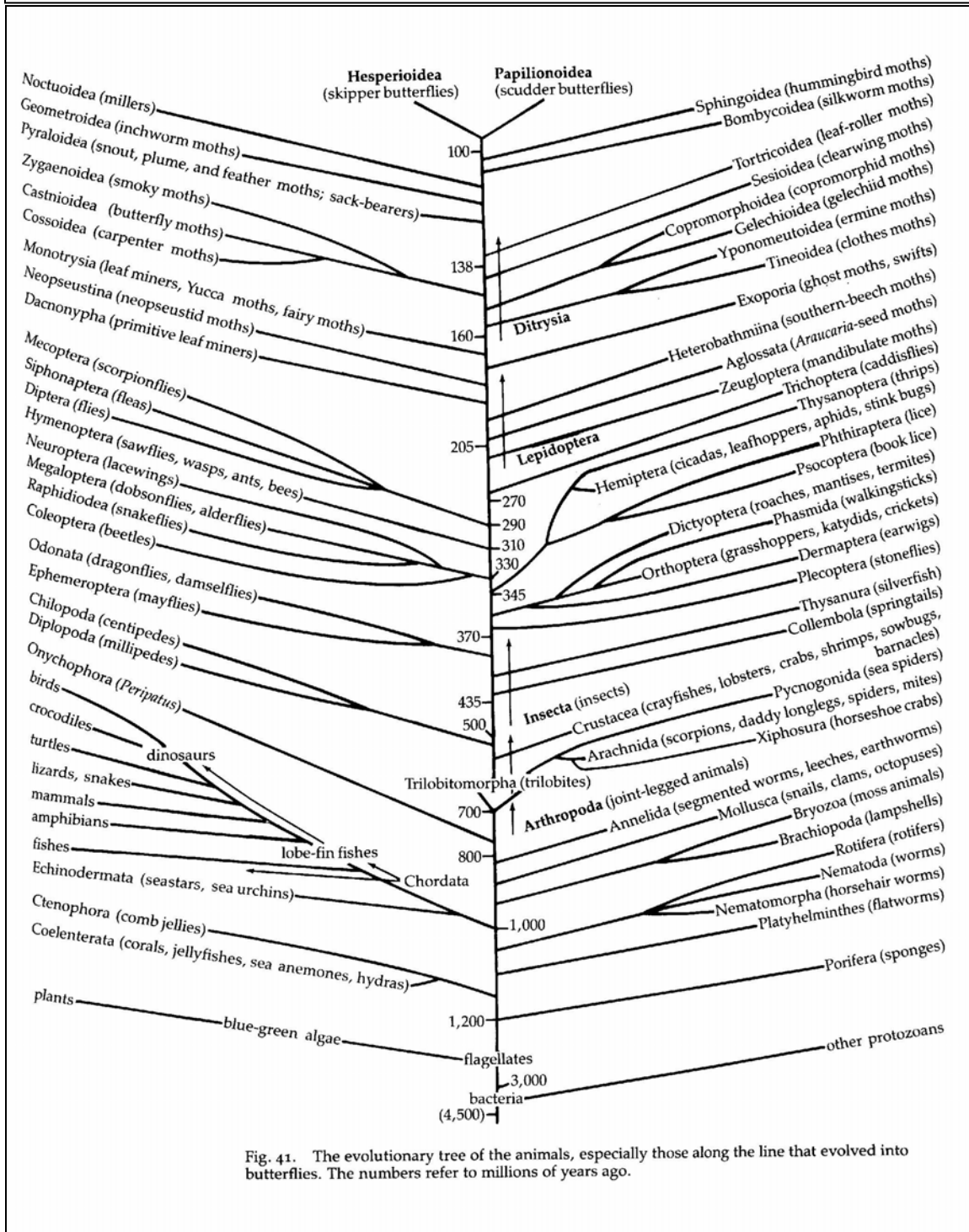
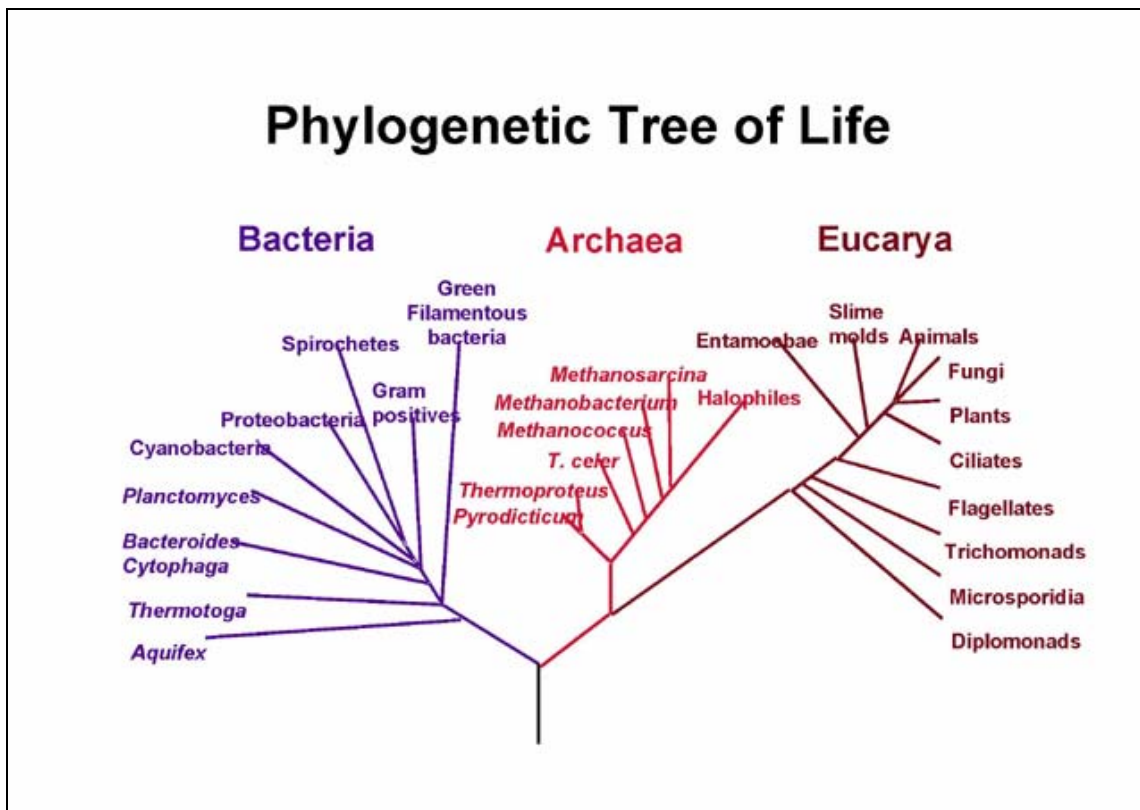

Fig. 41. The evolutionary tree of the animals, especially those along the line that evolved into butterflies. The numbers refer to millions of years ago.

Today, the most common representation of the full Tree of Life is something akin to the phylogenetic tree depicted in Figure 1.4. While some of the details of the tree are no longer accepted and some remain controversial, (e.g. Doolittle 2000, Andersson et al. 2003 on the Diplomonads), the broad scale pattern, such as the division of life into three great Domains – the Bacteria, the Archaea, and the Eucarya, has been generally accepted (Ciccarelli et al. 2006).

Figure 1.4 The three domain version of the Phylogenetic Tree of Life first produced in Woese (1990). The branch lengths are proportional to the genetic distances based on ribosomal RNA.



Unlike the trees of Haeckel and others from the period of roughly 1860 until 1960, modern phylogenetic trees have a very specific meaning and are read in a specific way. They are mathematical objects which have a specific interpretation and are not simply metaphors. Although there are certainly psychologically powerful factors that go into how we actually interpret them, it is important to be aware of these factors so that we can consciously avoid the biases to which we are prone. In order to understand evolution, it is important to be able to use and to properly read phylogenetic trees. As Robert O'Hara puts it, "Just as beginning students in geography need to be taught how to read maps, so beginning students in biology should be taught how to read trees and to understand what trees communicate" (O'Hara, 1997).

2. Phylogenetic Trees

The argument in this chapter depends in crucial places on properly understanding what a phylogenetic tree represents and how we make phylogenetic inferences using trees. In addition, important concepts, such as what a monophyletic group is, are easier to understand by referring to trees. For these reasons, I will provide a fairly substantial introduction to "tree thinking" before developing the key arguments of this chapter. Figure 1.5 displays the relationships of several vertebrate groups placed at the tips of a tree. The tips of a phylogenetic tree are usually referred to as the "taxa". The use of this word is of course not a coincidence as trees are typically understood to display the relationship between groups that we have named in our classification system. These taxa

share a common ancestor deep in the past. As time passes, we move up the tree and single lineages divide into descendant lineages. The nodes represent points of divergence – for example, at the first node, node y, one of these lineages eventually leads to the sharks while the other leads to the other four groups.

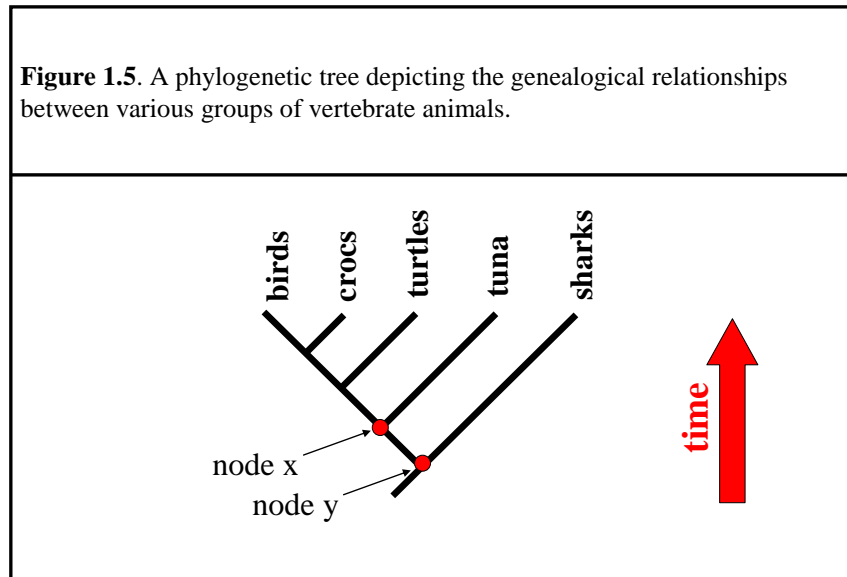

Groups shown on a phylogenetic tree are understood to be related to each other genealogically in the same way that individual organisms within a family tree are. You are more closely related to your first cousins than to your second cousins since you and your first cousins share grandparents rather than just great-grandparents. Similarly, tuna are more closely related to birds than they are to sharks since tuna and birds share a common ancestor at node x, while tuna and sharks share an ancestor at node y (which is earlier in time). There is an ancestor shared by tuna and birds (at node x) that is not an ancestor of sharks; on the other hand, every ancestor shared by tuna and sharks is also an ancestor of birds. By generalizing this example, one can see that horizontal distance among the tips on a tree means nothing when it comes to degree of relatedness. Though

it may seem that tuna and sharks share many properties that might lead you to believe that they are closely related, it is recency of common ancestry, not morphological similarity, that defines genealogical relationships.

It is easy to misread a tree. The horizontal distance between the tips does not have anything to do with how closely related two tips are to each other. We can reinforce this idea by pointing out that the tree contains the same information about relatedness even after certain types of rotations. For example, the two trees in Figure 1.6 convey the same information about relatedness:

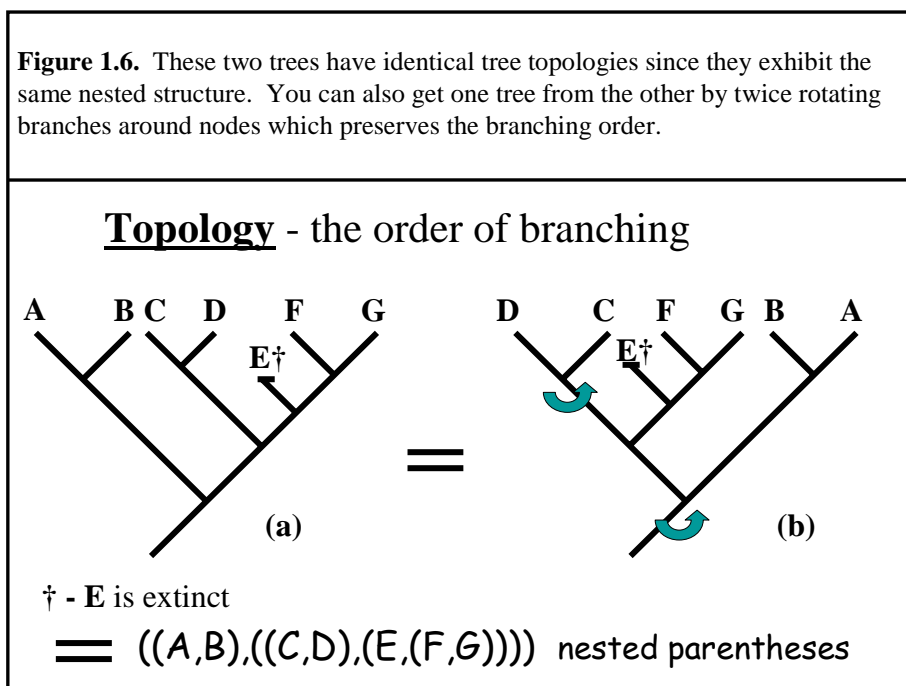

Each tree represents only a tree topology – the order of branching in order to get from the root to the tips. These trees are equivalent since you can get from one tree to the other through rotations around the nodes. To get from (a) to (b), simply rotate around the node

that leads to D and C and then rotate the branch leading to A and B around the root node. Since rotations around the nodes do not affect the vertical distance traveled down the branches, they do not affect the relationships represented on the tree. In other words, it is still the case that A is closer to B than to any other tip, C is closer to F than to B, etc.

Even armed with this knowledge, it is still easy to misread a tree. Figure 1.7 depicts two phylogenetic trees which appear to be quite different.

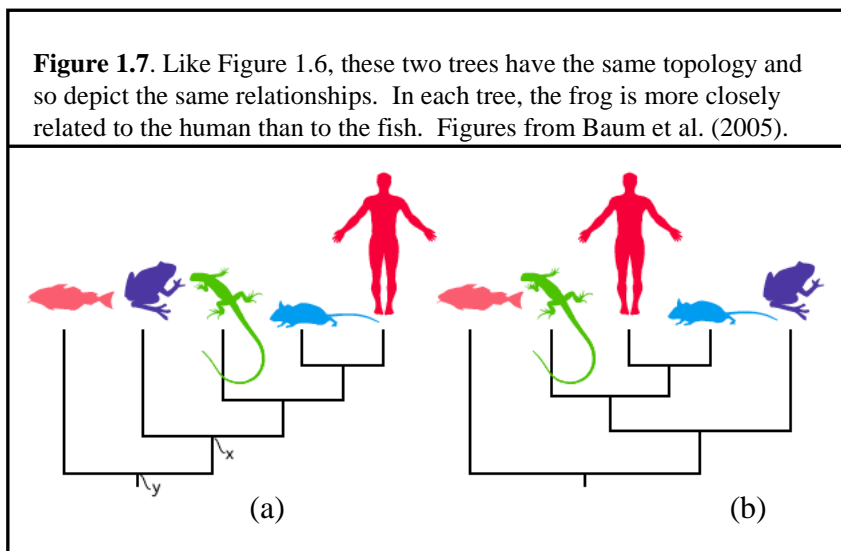

In the tree on the left (1.7a), it is tempting to conclude that the frog must be more closely related to the fish than to the human. This is incorrect – the frog has a more recent common ancestor with the human. This temptation is partially explained by the fact that to many people, frogs just seem much more similar to fish than to us. Also, there is a popular tale about how the story of evolution is the story that leads from fish to amphibians to reptiles to mammals and finally to humans which may subconsciously (or consciously) be influencing how we read the tree. But this "evolutionary" story relies on ladder thinking that is in fact inconsistent with proper evolutionary thinking – tree

thinking. While these might be significant factors, simply misreading the tree appears to be the best explanation of why students often make the mistake of inferring that the frog is closer to the fish (Baum ms.). The proper relationship – frogs are closer to humans than to fish – is easier to see in the tree on the right (1.7b). But these trees are equivalent since you can get one tree from the other just by rotations around various nodes. The correct way to show that the frog is closer to the human than to the fish is to trace back each lineage until you reach a most recent common ancestor. Frogs and humans share an ancestor at node x while frogs and fish share an ancestor only at node y which is earlier in time.

Another way of seeing that these trees are the same is by utilizing the concept of a monophyletic group. A monophyletic group consists of an ancestor and all of its descendants. Two nested monophyletic groups are depicted in Figure 1.8. Birds + crocs form a monophyletic group within the larger monophyletic group composed of birds + crocs + turtles. Groups are called “paraphyletic” when they include an ancestor, but not all of its descendants. Groups that include multiple groups of organisms, but that do not include their common ancestor are called “polyphyletic.” The most recent common ancestor of tuna and sharks is also an ancestor of birds. This means that tuna + sharks is not monophyletic.

Figure 1.8 A phylogenetic tree depicting a number of chordate groups. Monophyletic groups are nested inside more inclusive monophyletic groups.

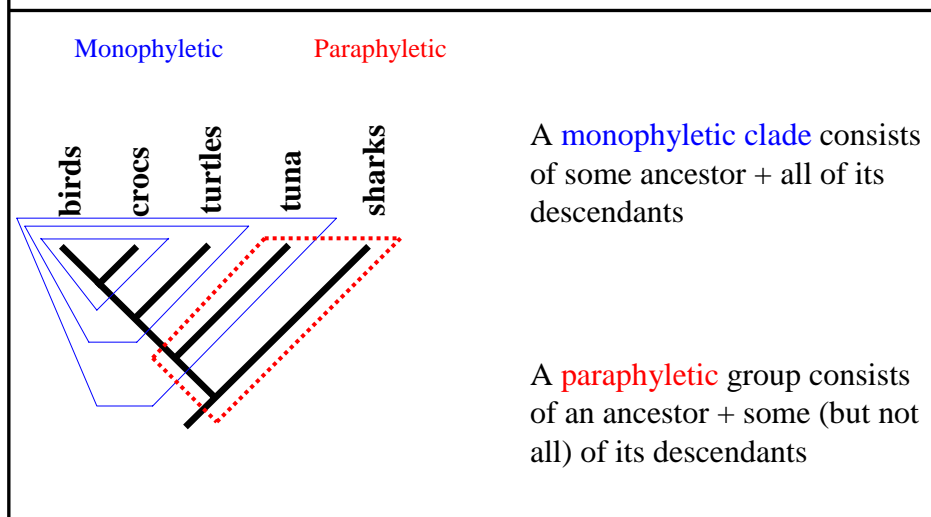

A tree is just a representation of which groups are monophyletic groups. A set of monophyletic groups yields a unique phylogenetic tree and vice versa. Referring back to Figure 1.6, each tree represents the same set of monophyletic groups: the group consisting of F and G is nested in a larger group E, F, and G [this nesting is represented as (E, (F,G))] and that group is nested in a larger group together with the group consisting of C and D, etc. Since the set of monophyletic groups formed in Figure 1.6a and 1.6b is the same, the trees are the same. Since in Figures 1.7a and 1.7b the groups are the same as well -(human+mouse, human+mouse+lizard, human+mouse+lizard+frog) – the apparently different trees must really represent the same tree.

A key fact about monophyletic groups that partially explains their importance is that in a purely diverging tree (i.e., one in which branches split but never join), a single time-slice of a monophyletic group forms a group that is genealogically exclusive –

members of the group at that time are more closely related to each other than any of them is to anything outside the group that exists at the same time (see Figure 1.9b). Non-monophyletic groups do not lead to exclusive groups. Exclusive groups can serve as valid tips of trees since there is a branch on the Tree of Life that leads to them and only to them.

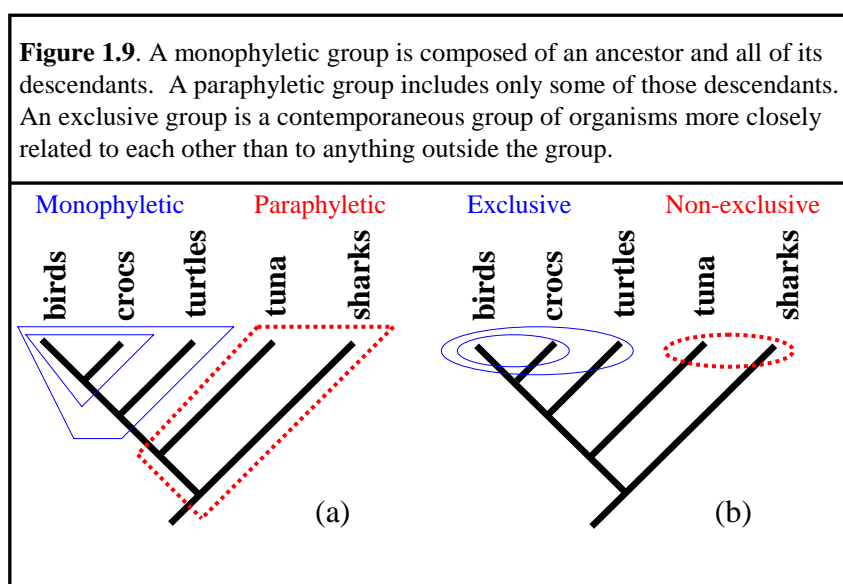

Because monophyletic groups share a unique history not shared by anything outside the group, it is possible to take a monophyletic group and “collapse” it into a single exclusive tip with a single lineage leading to it. For example, the “birds” tip in Figures 1.8 and 1.9 is already a collapsed lineage of around 10,000 living species, but it could be further combined with the crocodiles to form the Archosaurs – a group that includes the dinosaurs (see Figure 1.10a). This is acceptable since everything outside of

the Archosaurs (for example, the turtles) is equally related to every archosaur.

Monophyletic groups form “clades” – branches on the Tree of Life.

Just as a monophyletic group can be collapsed, it can be expanded as well. A tip that forms an exclusive group can become multiple tips if there are multiple exclusive groups inside it. Since the original tip was an exclusive group, doing this does not disturb the rest of the tree in any way. For example, in Figure 1.10a below, two groups of turtles are placed on the tree. These two groups do not exhaustively cover all turtles. Since turtles form an exclusive group, every non-turtle is equidistantly related to every turtle, whether a snapping turtle or a sea turtle – just as is true of the groups depicted in figure 10a.

If a non-exclusive group such as the traditional “Pisces” (fish - including tuna and sharks) is placed on the tip of a tree, it will lead to mistaken inferences about evolutionary history. This is because the branch leading to this group cannot represent real historical lineages since there is no lineage that leads to both tuna and sharks without also leading to birds and a host of other groups. Placing “fish” at the tip implies that all non-fish, like turtles, are equally related to every fish. But this is not true; for example, turtles (and all tetrapods) are more closely related to tuna than they are to sharks. Just as “fish” is a paraphyletic group, “reptiles” (if it includes crocodiles and turtles but not birds) is too, so we cannot put reptiles at the tip of a tree unless we include birds in the reptiles. If we did, we would be misled if we attempted to use the resulting “tree” to infer anything about the history of the groups in question such as determining the dates of nodes, the history of character changes or biogeographical changes, or simply determining genealogical relations among groups.

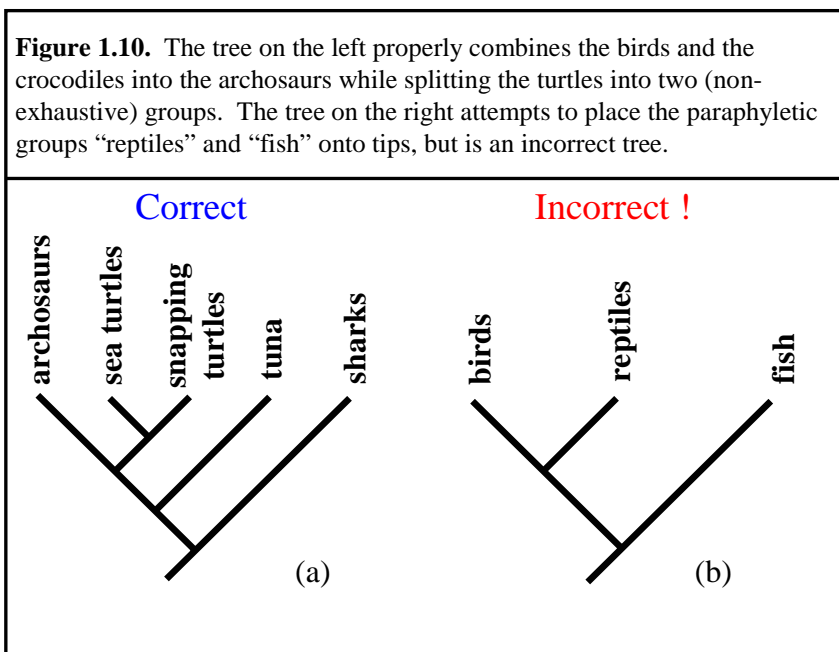

No matter where we try to place a non-exclusive group on a tree, it will have false implications about evolutionary history. For these reasons (and others) it has become an accepted principle of systematics that taxa (the groups of organisms which we seek to formally name in our classification system) must be monophyletic. When traditional groups such as Reptilia and Pisces are discovered to be paraphyletic, they are readily abandoned as taxa. Of course this is not to say that there is no reason to consider Reptilia and Pisces as “real groups” or to stop using their names in all contexts. Rather, these groups are not taxa – they are not part of the single all-purpose classification system that is used to store and communicate information in an efficient manner (see Hennig 1966). An oceanographer may be interested in studying the whales, plankton, and various fishes and other organisms that inhabit a certain geographical location, just as an economist might be interested in studying the group of humans that have graduated from the University of Wisconsin-Madison. The fact that the organisms in these groups share

interesting properties should in no way lead us to demand that they are taxa in our biological classification system. Similarly, Reptilia and Pisces can be interesting as objects of study and can be defined as groups of organisms without leading to the conclusion that they must be taxa.

3. Why paraphyletic groups are bad

To see the importance of using only clades as taxa, it is worth looking at one controversial example. It shows that is not simply a convention that we read trees the way we do – rather, it is necessary if we want to use trees for inference problems that involve the genealogical history of various groups. For example, Figure 1.11 depicts the proper phylogeny of a few of the major clades of reptiles and birds:

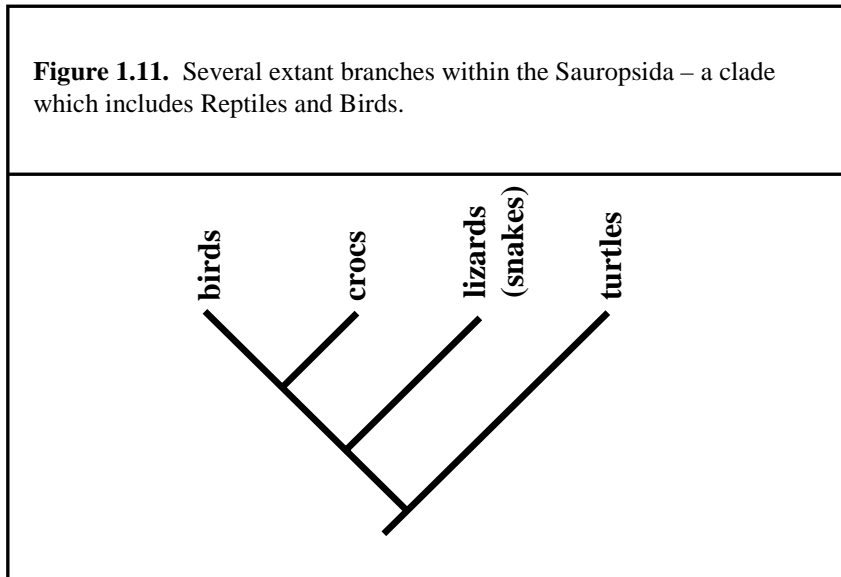

The snakes are nested inside the lizards and so are placed in parentheses. Here, each tip is an exclusive group each of whose members can stand in for the genealogical relationship of any other member. For example, every bird has the same relationship to any organism in any other clade including any croc, any lizard, and any turtle. Here, the nodes represent real divergence points – birds and crocs share a common ancestor about 245 million years ago (mya), birds and lizards about 265 mya, and birds and turtles about 300 mya (Dawkins 2004). The branches represent real lineages that lead to organisms at that tip and none of the other tips. This is essential for tracing the effect of evolutionary changes along the branches. When we study the effect of trait evolution, it is essential that we know the underlying phylogeny. For example, the gizzard is an organ that both birds and crocodiles have, but that no other living reptiles have. It is a kind of specialized stomach, attached to the “true” stomach, which allows these organisms to swallow stones and then use them to aid in the breakdown of food which can pass back and forth between the glandular stomach and the gizzard.

How and when did the gizzard evolve? Given the true phylogeny, we can infer that it probably evolved on the indicated branch which leads to both the birds and the crocodiles but leads to nothing else as Figure 1.12.

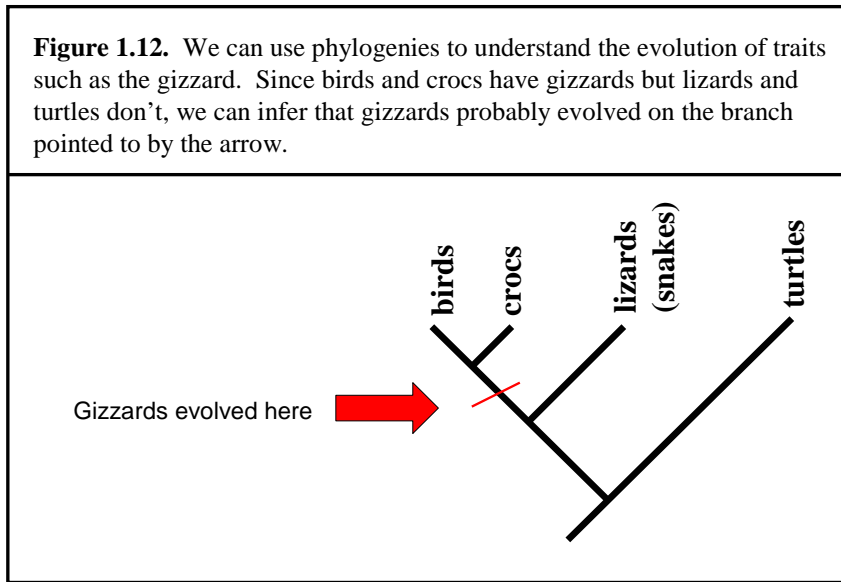

That would mean that it evolved between 265 and 245 million years ago and has simply been inherited by both birds and crocodiles which are both descendants of this branch. Incidentally, this would mean that the dinosaurs also had gizzards as they are on the branch leading to the birds. Of course this is subject to error – for example, it is possible that the gizzard evolved earlier and it was simply lost in the branch leading to the lizards. Alternatively, it is possible that the gizzard has evolved twice. In fact, some other organisms have gizzard-like organs such as certain fish and even earthworms. Again, with the proper phylogenetic tree, it is easy to see that either massive numbers of groups have lost the gizzard, or it has independently evolved in the fish, earthworms, and the archosaurs. In fact, a detailed examination of the “gizzards” in the earthworms and the fish makes it clear that many of the similarities are only superficial and in an important sense, these are not really the same character traits being expressed in the

different groups unlike in the crocodiles and the birds where the gizzard truly is the same character.

On the traditional picture in which we incorrectly classify birds in class Aves and reptiles (like crocodiles) in class Reptilia it is very tempting to place reptiles at the tip of a tree as a sister group to the birds as in Figure 10b. As noted above, this is incorrect. In fact, it is easier to see this when we try to expand the reptiles into their traditional orders like this:

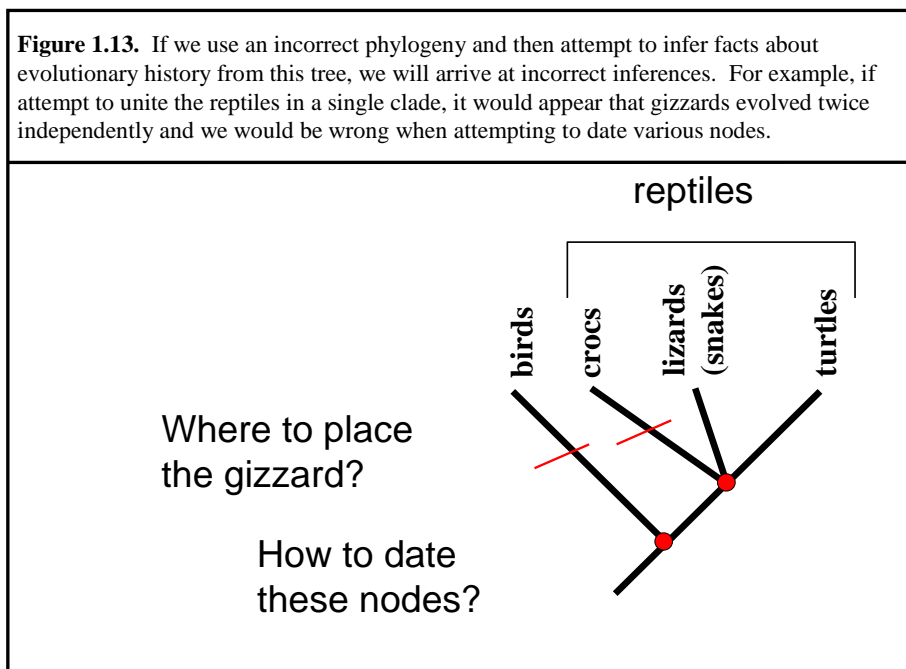

Here, assuming that the gizzard did evolve only once and spread to birds and crocodiles, that proper explanation is blocked since there is no branch on this diagram where the gizzard could have evolved. Instead, it looks like a massive coincidence that birds and crocodiles would share such detailed similarities like the gizzard and all of its natural

components. This is especially odd given the obvious ecological differences between birds and crocodiles which would lead to the apparent conclusion that they have been under very different selection pressures for quite some time.

The fact that this tree cannot correspond to genealogy is also easily seen by trying to date the nodes. Exactly when did birds split from reptiles? On this tree, it appears as though you could use crocodiles, lizards, or turtles equally as your comparison group since they all appear equally related to birds. Or perhaps to maximize the strength of your evidence, you should look at all of the groups and do a sort of averaging of the evidence. But this would be a mistake since birds are related differently to different groups of reptiles. The group leading to birds diverged from the crocodiles about 245 million years ago, diverged from lizards about 265 mya and from turtles about 295 mya. Similarly, it becomes impossible to see that lizards are equally related to crocodiles and birds, but more distantly related to turtles, etc. This has dire consequences when we try to use trees to make inferences. Genealogical trees are essential for testing selection hypotheses, testing models of rates of evolutionary change (such as the molecular clock hypothesis), doing comparative biology (are traits X,Y correlated), and for testing biogeographical hypotheses. Essentially, any inference that requires knowing the history of any groups will require an estimate of the phylogenetic tree. Knowing a traditional classification of this group or knowing which groups are similar to other groups helps only insofar as it is a good guide to the true genealogy – where the latter is what is actually required.

We now have arguments that it is necessary that any taxon, a group placed at the tip of a tree, must be a clade. If we are going to ask questions such as “when did this

group originate, when did this group diverge from this other group, has group X undergone anagenetic change faster than group Y has?, etc the groups in question must be clades.

Of course “taxa” is also the word used for the groups in our formal classification system. If only clades can be taxa (groups at the tips of trees) because only clades fit in the right kinds of biological generalizations, many biologists have thought that it is natural to think that only clades can be taxa (groups in our classification system). Since these two groups are typically thought to be coextensive, distinguishing between them is rarely necessary. But to be careful, we should clarify that whatever groups you decide to give scientific names to, only clades can be used as the tips of phylogenetic trees.

Traditionally, just knowing that a group is a taxon is important, but there is a further question of what rank it should be. Current taxonomic theory divides the world up into different types of taxa – for example, some are genera whereas other are families. Delimiting taxa is only part of taxonomy. We also have to determine which taxa belong at which rank in the taxonomic hierarchy.

4. Ranking

A key distinction for phylogenetics is that of grouping vs. ranking. An important aspect of understanding evolution is the idea that the results of descent with modification are the formation of groups within groups. How to determine which groups count as taxa is the basis for the “grouping” criteria. Historically, groups were just phenotypic clusters. But as in any type of hierarchical classification, these clusters themselves are parts of larger clusters. The idea behind ranking is that we start with species – the basal clusters. Then

we move to a genus which is just a cluster of species that are sufficiently similar. A family is a cluster of genera that are sufficiently similar, etc. Moving up the hierarchy, since plants and animals were considered to be very different kinds of things, they were placed in different kingdoms.

Ranks were formally introduced into classification by Linnaeus and taxonomy itself has a very long and philosophically interesting history (Ereshefsky 1997, 2001; Larson 1971). The ranking system itself has also undergone significant evolution but a common presentation of the ranks might look like the following:

Figure 1.14 The primary ranks in the modern Linnaean hierarchy from least inclusive (species) to most inclusive (Domain).

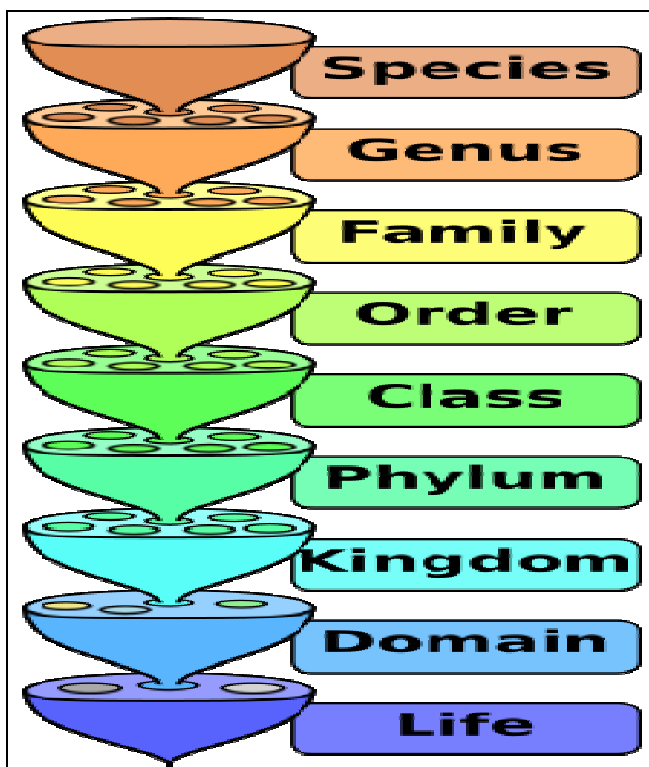

This type of diagram makes clear that a species is simply one of many species inside a genus, a genus one of many genera inside a family, and so on. Since life has turned out to be far more diverse than Linnaeus or nearly anyone else for hundreds of years suspected, today's taxonomy makes use of newer ranks such a tribe which is between a genus and a family and cohort which is between order and class as well as adding a number of "intermediate" ranks so that we can move from a family to a superfamily, parvorder, infraorder, suborder, order, and superorder and up through more intermediate ranks again before we reach cohort. Taxonomists are free to add ranks of their choosing at any time, but it is safe to assume that current usage includes at least the 24 ranks which are specifically mentioned in the International Code of Botanical Nomenclature (ICBN 2006).

Today, systematics and therefore classification is dominated by phylogenetic thought. We are slowly reaching toward Darwin's goal that classifications reflect genealogical considerations. The groups within groups are genealogical groups. A genus is a group of species that are united by common descent while the family is simply a more inclusive genealogical group. Just as a family reunion where all the descendants of one set of your grandparents get together is just a subset of the individuals who would come to a family reunion of the descendants of one set of your great-grandparents, so a taxonomic genus is just a subset of the taxonomic family.

In phylogenetics today, there is a single grouping criterion – monophyly. All higher taxa must be monophyletic – that is, all and only the descendants of some common ancestral species. Apes are a monophyletic group inside of primates, which is a

monophyletic group inside of mammals. Thus the taxa that form the “groups within groups” that are the result of descent with modification are the monophyletic groups.

Ranking is the procedure by which we assign some particular group a rank in the hierarchy. Once we have established that something is an acceptable group (namely, it is monophyletic) we can then go ahead and ask what rank, if any, it has. For example, the great apes form a monophyletic group which today is represented as the family “Hominidae” (following Groves 2005). But should the great apes be elevated to the more inclusive rank of superfamily with several families within it? Or perhaps lowered to a mere subfamily as a part of a larger family?

Unlike the criteria for grouping species together into a taxon, the ranking criteria is something that is heavily debated in systematics. Even in the cases where all parties to the debate agree upon the relevant criteria that matter for the rank of a group, there are debates about what rank a particular group should get. But matters are far worse – there are even debates about whether there should be such things as ranks at all! While one influential group of phylogenetic systematists argue that ranks are theoretically and practically useless, others believe that ranks are of practical use and should be kept – but acknowledge that there is something deeply conventional about ranks. A third position, which is becoming far less prevalent over time, is that the different ranks truly do represent real distinctions in nature and as such, there is something intrinsic which marks the distinction between a genus and a family and our classification should attempt to capture these distinctions.

If we insist on keeping grouping and ranking separate, then we can in principle do all of the grouping of species into taxa and then ask the second stage question of which

taxa should be assigned which ranks. As an example, (admittedly, one of the most controversial), we can examine the taxon consisting of humans and their closest cousins. Of course the proper classification almost always depends on who you ask for most reasonably sized groups, but here is a fairly standard presentation of how to divide up the Tribe Hominini (from Groves 2005):

Tribe Hominini includes:

Subtribe Panina

Genus *Pan* (chimpanzees)

Subtribe Hominina

Genus *Homo* (humans)

extinct genera:

†*Paranthropus*

†*Australopithecus*

†*Sahelanthropus*

†*Orrorin*

†*Ardipithecus*

†*Kenyanthropus*

Here, all humans that are currently alive are members of the subspecies *Homo sapiens sapiens* which is the only extant subspecies of the species *Homo sapiens*, which is the only extant species of the genus *Homo*, which as we can see from the classification above, is the only extant genus of the subtribe Hominina. But of course other

classifications are possible. Ranking seems to be at least in part some sort of measure not just of difference, but of the importance of the differences. After all, once we allow for the weighting of characters, we can achieve nearly any kind of ranking that we want.

To be precise, let's talk about the taxon that today is known as the genus *Homo*. This genus consists of around 15 known species. It is tricky talking about the history of classifying this taxon as its content is constantly shifting due to new fossil finds. But it is clear that the traits such as bipedalism, increased cranial size, and the use of stone tools that today characterize the genus *Homo* have been thought to be much more important for ranking in the past. Julian Huxley once proposed that this taxon be recognized as Kingdom Psychozoa – and so we would no longer be animals (Huxley 1958). One hundred years earlier, Richard Owen proposed that the taxa should be the subclass Archenacephala (Owen 1858). In the 20th century, competing systematics textbooks had the taxon as both the family Hominidae (Simpson 1961) and the tribe Hominini (Wiley 1981). Since Hominidae is by definition the family which contains the genus *Homo*, Wiley was forced to use the name Hominidae for a different taxon which he believed consisted of all of the great apes. Thus not only was there dispute about what rank (and therefore, name) to give to some particular taxon, but there is also a dispute concerning which taxon a particular name refers to. The rules of nomenclature plus the subjectivity built in to the system of assigning ranks virtually guarantees that these sorts of disputes will be common throughout the biological world and the unsuspecting reader can easily misunderstand some vital piece of taxonomic information because of these disputes.

Today, we think that both Simpson and Wiley thought too highly of the differences between humans and non-humans such as the Chimpanzees. Today, the

particular taxon of interest is simply the genus *Homo* and as we saw earlier, Humans and Chimps are part of the same tribe - Hominini. But some systematists think that we are still being too anthropocentric in thinking that we are different enough from chimpanzees to be considered different genera. In his popular account *The Third Chimpanzee*, Jared Diamond defends the view that the particular taxon in question should not even be a complete genus (Diamond 1992). Instead, he argues that humans and chimpanzees should be in the same genus. Humans, the common chimpanzee, and the bonobo would thus constitute three species in the same genus. By the rule of precedence, *Homo* must be the genus that we are in since *Homo sapiens* is its type specimen. Thus the common chimp, *Pan troglodytes* and *Pan paniscus*, would become members of our genus and so would be renamed *Homo troglodytes* and *Homo paniscus*. This view has been repeatedly defended over the years – typically by those who point out that on the molecular level, humans and chimps are far more similar than some species which are considered to be members of the same genus (see Goodman et al. 1998 and Watson et al. 2001 who also include the Gorillas in the genus).

In this particular case, everyone agrees on the content of some particular taxon – what is currently called the genus *Homo*. What is at issue is what rank in the taxonomic hierarchy it should receive. This is a matter of how relevantly different it is from other taxa. But this is a subjective matter. The fact is that there is no fact of the matter about what rank it should have because there are no facts in nature that could dictate that a particular taxon be assigned the rank of genus, or of family, etc. It is an arbitrary matter how we choose to use these terms.

5. Are ranks even consistent?

While the dominant trend in systematics has been toward a preference for monophyletic taxa, a few authors have noted an obvious problem with this trend – we can't have every taxon be monophyletic as that is just straightforwardly inconsistent with our rules of taxonomy! For any particular group, we can force it to be monophyletic only by shifting the content of other taxa around such that some other taxa will still be paraphyletic. This has been repeatedly pointed out by authors angered by the idea that there is something unacceptable about paraphyletic groups (Brummitt 1996, 1997, Sosef 1997, Brummitt and Sosef 1998). So must we necessarily give up our hope for a purely phylogenetic systematics? No. Requiring that all taxa be monophyletic is not straightforwardly inconsistent – rather, it is inconsistent when it is combined with a few principles of traditional Linnaean classification. In particular, it is inconsistent when combined with various rules of the ranking system.

One source of contradiction arises in connection with classifying ancestral species. Imagine that species A gives rise to two species B and C. Now each of these species must be assigned to a particular genus. Call the genus that species A is assigned to genus X. But now since genus X must be monophyletic, it is easy to see that species B and C must also be in genus X. But this argument obviously generalizes – species A itself must have an ancestral species which now must be in genus X as well. This argument simply repeats until we reach the conclusion that all life must be part of the same genus. Of course the same argument works for every rank in the hierarchy. Assuming that species X and species Y are members of different higher taxa (say different families) leads to a contradiction – simply ask what family their most recent

common ancestor is a part of. As Hennig puts it, the stem species of the class Aves must be a member of Aves, but it cannot be a member of any of its subgroups (Hennig 1966).

Defenders of a purely phylogenetic taxonomy get around this problem by refusing to classify ancestral species. Rather, these common ancestors are merely “hypothetical common ancestors” (Nelson and Platnick 1981). When we classify fossils, we simply treat them as any other tip. We can’t assume that they are actually the ancestor of any particular group. In fact, given the rarity of fossilization and the frequency of extinction, any particular fossil is probably not the ancestor of any extant groups. The fossil is just put at the tip of a tree (not at an interior node) like anything else and then is part of the hierarchy of clades in just the same way. There is no special problem of ancestors.

But as Brummitt points out, we can show a logical inconsistency with the rules even for unnamed species simply by assuming that there is such a group. It is enough of a problem that *if* we did try to name an ancestral species we would not be able to follow the rules. It is not necessary that we actually have a fossil and that we try to do so in order to recognize the problem.

If we are concerned about how we could classify ancestors, we could simply deny that ancestors are classified in the same way that currently living species are. Perhaps we do want every *living* species to be placed in some genus or other, but there is no reason to demand that *extinct* species be placed in genera as well. As the rules currently stand, for any named species, extant or extinct, if it is in the animal kingdom, it must be placed in a genus and a family at least, if it is a plant, the mandatory ranks are genus, family, and

order. It is certainly a viable option to simply modify our rules of nomenclature such that we would not be required to classify ancestral species into various genera and families.

There are theoretical reasons to resist assigning ranks to ancestral species besides the fact that it is inconsistent with the current rules. But rather than focus on this limited task, I will simply attack the problem much more broadly by arguing that the entire system of ranking is theoretically and practically flawed. Although the current nomenclatural codes still focus on continually modifying our taxonomic rules in order to keep a system of ranking, the dominant trend in systematics is certainly moving away from the position that ranks are theoretically motivated and practically useful. Almost all systematists accept that there is no theoretical basis in nature for assigning a particular taxon to the rank of genus rather than family. The question has now become what should this fact lead us to do about ranks? We could continue to maintain their use and simply modify the rules of ranking to try to capture something theoretical. We could simply acknowledge that there are no objective, mind-independent facts about ranks but justify continuing to use them because they can have a conventional meaning, or we can simply discontinue their use all together. The current state of affairs is certainly not ideal. But what is to be done about it? We certainly want to avoid changing our taxonomic practices only to move to a system which is even worse than the one we started with.

6. Why sister groups must have the same rank

Here I discuss the status of ranks once we have in place a phylogenetic system of

grouping taxa. It is important to recognize that when all taxa are clades, sister clades must have the same rank. Why is that? Well, imagine that they didn't. For a specific example, let's look at the great apes (family Hominidae) in Figure 1.15. On this tree, humans are sister to chimpanzees. Let's imagine that they have different ranks as in fact was the case historically before the advent of phylogenetic classification. For example, Simpson argued that humans and their close relatives are in fact the only members of family Hominidae and that chimps, gorillas, and orangutans form a separate family, Pongidae. We now know that among the four major groups of great ape, humans and chimps are sister groups forming a clade that is sister to the gorillas, with orangutans being the outgroup.

Let's examine the group containing just humans and the close relatives. Let's call it *Homo*. *Homo* is certainly a genus. But perhaps it is also the only member of the family Hominidae, as Simpson thought. If that is the case, what rank should we give to *Pan* which contains both the common chimp and the bonobo? The answer is that it must be a family as well. If it is only a genus, we will run into problems. The International Code of Zoological Nomenclature determines that family is a mandatory rank. That is, every genus must be in some family or other. So what family should *Pan* be in? It cannot be in Hominidae since that includes only humans. So it must be in some other family. But now let's look at the group which includes humans, chimps, and gorillas. If it is not a taxon, simply go to the next largest clade that is a taxon. Now, what rank should we give this taxon? It includes the family Hominidae so it must be larger than a family. But now if *Pan* is not elevated to the rank of family, it will not be in any family since the immediately larger taxa which contains it must be larger than a family. So we can see

that humans and chimps cannot have different ranks. But of course the argument is perfectly general – any two sister groups on a tree must have the same rank or else one of the groups will not be able to be placed in one of the mandatory ranks.

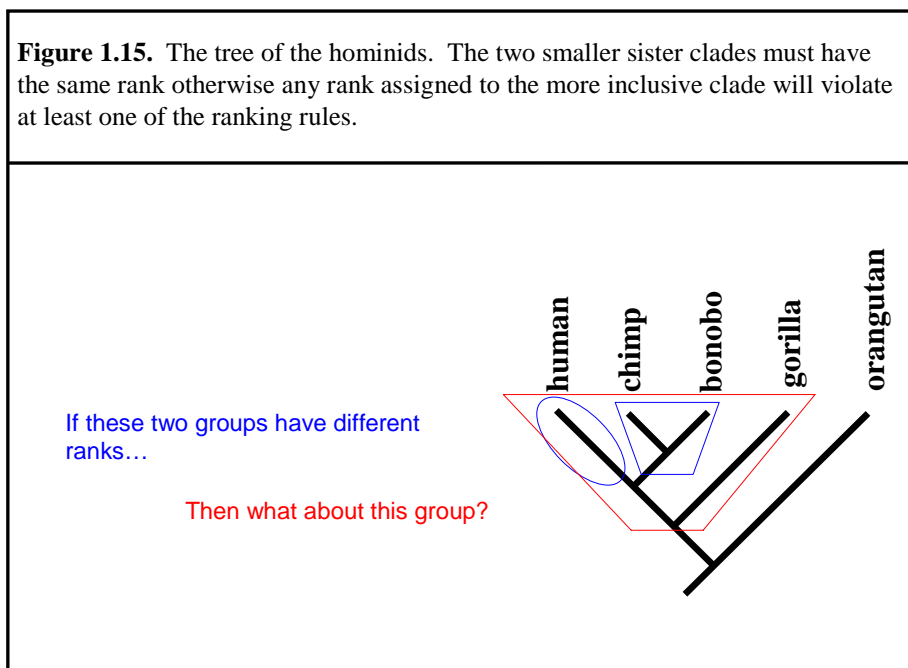

To be more precise, if a group is placed in a rank which is a mandatory rank, then its sister group must share that same rank. If it placed in a non-mandatory rank, there is not necessarily a problem. For instance, if humans formed a tribe and chimps a genus, then humans+chimps+gorillas could form a family. Now chimps are not in any tribe, but there is nothing wrong with this. It certainly violates the spirit of the code, if not the letter, by using the rank of tribe for humans, but not their sister group the chimps. This is perhaps easiest to see when we start from the standpoint of the family. A family consists of a collection of genera, but sometimes we want to add more structure so we group the

genera into tribes and say that the family consists of a set of tribes which themselves are sets of genera. But on our classification above, we have the family divided up into a tribe and two genera.

Although technically, we need to add the claim about mandatory ranks to be sure of a violation of the rules, I will continue to claim that sister groups must have the same rank. To be precise, we know that this is short hand for “if two sister groups are both taxa and one is of a mandatory rank, then the other must be of that same mandatory rank”. Of course as we have seen, this is a bit more general than it seems. Although ranks such as “subtribe” are not mandatory ranks, this merely means that across all groups of animals, it is not necessary to split a tribe into subtribes; but rather, sometimes the tribe can be split directly into genera. But as was just mentioned, the purpose of ranking seems to be defeated if we have a subtribe within a particular tribe and then to have some genera *within that very tribe* not in any subtribe at all. To avoid this, in the case of Hominini above, since *Homo* and several other genera are placed in a subtribe Hominina, the genus *Pan* is also placed in a subtribe – Panina. But while we avoid violating the rules, we can now see another odd feature of ranking – in the same classification, the subtribe Panina and the genus Pan are coextensive – that is, they refer to exactly the same group of organisms. This is known as a monotypic subtribe and groups like this are ubiquitous throughout classifications. This certainly seems to play havoc with the view that for some particular taxon, there is an objectively correct answer to the question of what rank it should be. Here, the very same taxon has multiple ranks in a single classification. But this is merely one issue among many that ranking seems to

raise and within a phylogenetic classification system, it cannot be avoided simply by reclassifying various taxa.

Though it may seem like we are undermining the very principles of ranking, we have a logically sound argument that if we allow only clades as taxa, then sister groups must have the same rank. This is particularly awkward for some older taxa. For example, the birds are traditionally a class, while the crocodiles form an order. To follow phylogenetic rules, these rankings would have to be adjusted to be the same. But the reason that they were ranked differently in the first place is that Aves and Crocodilia do not seem to be comparable in the relevant ways. There are approximately 10,000 living species of birds while there are only 23 living species of crocodilians. In fact, there about two dozen orders within class Aves each of which is has more species than Crocodilia. In term of the amount of internal branching, its internal phenotypic diversity, its distinctness from related taxa (crocodiles are far more similar to lizards than birds are), and its adaptive novelties, Aves and Crocodilia clearly are not comparable as ranked groups. Yet a phylogenetic classification system must rank them the same.

7. Rank as Age

With the current ranking rules such as mandatory ranks and a taxon at some rank not being able to include any taxon of equal or higher rank, we have seen that it is impossible for ranks to be a measure of morphological diversity, branching diversity, phenetic distance from a sister group, or any combination of the above. However, there may still be hope for keeping ranks. Hennig suggested that the rank of a taxa could correspond to its age (Hennig 1966). Since geological time periods are classified by their age, it might

be natural to have one list correspond to the other. For example, ranking a group as a class might mean that it originated in the Permian period, which is between approximately 300 and 250 million years ago. Giving a group the rank of family might indicate that it arose in the Cretaceous between 145 and 65 million years ago. With a few careful distinctions, the age of a taxon appears to be objective and thus meets at least one criterion for being theoretically meaningful. This has the benefit of creating a common meaning for the categorical ranks that survives across different parts of the Tree of Life. Currently, the fact that Insecta and Aves are both ranked as classes doesn't really mean that they are comparable in any interesting way other than perhaps as a reflection of what some individual person or group of persons hundreds of years ago thought about the relative importance of the two groups. In the ranks-as-ages picture, saying that two groups are both classes actually does mean that they are relevantly comparable. Incidentally, since the oldest known insect fossil are estimated to be about 400 million years old while the oldest bird fossils are closer to 150 million years old, it is clear that on this picture, these particular groups would not be the same rank. As far as I am concerned, this difference in ranking between Aves and Insecta is a mark in favor of the ranks-as-ages view. There is nothing special about Aves and Insecta either. Once we begin to compare taxa from different parts of the phylogenetic tree, there is no guarantee that groups will be remotely comparable. For a few examples focusing on age, some species of fruit flies in the genus *Drosophila* last shared common ancestors >40 million years ago whereas some primates currently placed in different families separated within the last few million years, and some cichlid fishes placed in different genera diverged within the last few thousand years (Avise and Johns 1999).

Hennig himself later gave up the idea that ranks should represent ages (Hennig 1969) and it did not see much popularity over the next 30 years. However, given the obvious theoretical problems with ranks as they are currently used, it is certainly essential to examine any reasonable proposals for trying to keep ranks before we take the apparently large step of getting rid of them all together. In recent years, ranks as ages, or something similar has been suggested by a number of authors. Goodman et al. (1998), and Groves (2004) apply the ranks as ages idea to classify the Primates while Avise and Johns (1999) and Avise and Mitchell (2007) have proposed that our classification system should include estimated ages as part of the names of the groups, as a way of adding more information to our classification system. There are certainly some reasons to do this and some reasons not to. But if it is a good idea for the name of a group to convey information about its age, then it is not much of a leap to think that this same information can be easily encoded into our ranking system which is meant to serve exactly the same function – namely, adding to the information content of the name of taxa.

Besides the obvious practical issues associated with ranks as ages such as stability concerns when we change our estimates of the age of a group (which happens frequently), again we run into problems when we consider the ranking rules. As before, classifying ancestral groups will violate the ranking rules. If a group went extinct 200 million years ago, it certainly can't be part of any genus. But Hennig and other phylogeneticists would certainly see this as an obvious advantage. It reinforces the view that groups that we now recognize as very different, such as the birds and the crocodiles, would have been very similar 200 million years ago. Groups that leave living descendants that should now be classified as different orders were merely different

“families”, different “genera” and merely different species at various points in the past. Similarly, groups that we now see as different species in the same genus might appear as founder species of different genera, families, or orders from a vantage point far in the future. This point has been made regarding Gould’s claim that something very important must have happened in evolutionary history for a large number of phyla to suddenly appear in the fossil record after the Cambrian Explosion. Nothing important had to happen at all! At the time, nothing other than speciation and divergence as normal would have led us today, 350 million years later, to see these groups as the founders of vastly different phyla.

There are also issues with mandatory ranks that have nothing to do with extinct taxa. For example, some groups go a very long time without splitting (or perhaps there have been splits but we have never found any of the fossils that correspond to the relevant groups). Here we might know of a split at one geological period and then pass through an entire period before two new taxa originate from it. This means that there would be no subgroups at the rank corresponding to the passed over.

So at least one of the rules that has to go is mandatory ranks. But as we argued before, mandatory ranks probably have to be eliminated anyway. But there are further issues with ranks-as-ages. For example, some splits occur very near each other. For example, a clade may be 290 million years old and then contain two clades within it that are each 270 million years old. Each of these three groups thus originated in the Permian. But this would mean that one class is completely contained inside another class at the same rank. This violates another of the rules of ranking. There are various ways of getting around this – perhaps we could have a series of ranks that all correspond to the

Permian – such as superclass, class, subclass, infraclass, etc. Then we could still gain information about the age of a group without violating any of the rules of ranking; although as in the case with sister groups that have different non-mandatory ranks, this does seem to violate the spirit, if not the letter, of the nomenclature laws.

We have argued that it is possible to preserve the use of ranks in phylogenetic classification if they refer to age alone, we get rid of mandatory ranks, and we violate the spirit of much of the purpose of ranks. Not only is it unclear whether or not this actually is the best version of keeping ranks, but it is unclear whether this even counts as using “ranks” at all.

Given all of the changes that must be made to the ranking system in order to preserve it, it is worth asking whether it is worth preserving at all. Hennig himself later changed his mind about the ranks-as-ages proposal (Hennig 1969) and most phylogenetic systematists have followed suit. Traditionally, ranks were needed in order to gauge which taxa were comparable. For example, Aves and Reptilia were both given the rank of class (as were Mammalia, Amphibia, and Pisces) in order to show that these were the comparable groups within the larger group of the phylum chordata. But with a phylogenetic grouping procedure, it is not necessary to use ranks to see what groups are comparable when they are within the same larger taxon. Rather than having the sister groups be two families that are within the same order, sister groups are simply two taxa that descend from the same ancestral species. This does leave a gap in determining which groups are comparable when they are not sister – for example, traditionally, it would seem that Insecta and Aves are both comparable as they are both ranked as classes. But since they are from distinct portions of the tree, if they are simply unranked

clades, it is not clear whether Insecta is comparable to Aves or not. As pointed out before, this is as it should be since they clearly *are not* comparable in a host of ways.

Once we understand that we are engaged in trying to understand how groups of species are related to each other, a clear picture emerges that it is not essential in any way to give these groups ranks. It may be that for classification purposes, some information can be conveyed by adding a rank to the name of a particular taxa, but as we have seen, it is difficult to have any ranking system which actually provides more useful information than misleading information. Phylogenetic systems of nomenclature such as the PhyloCode make it clear that we can perfectly well get along without ranks. The preceding arguments which led to the conclusion that the only way in which taxa can be comparable at a hierarchy of levels is by comparing their ages is best seen not as a reason to think that the traditional Linnaean ranks should be used to represent the ages of the taxa in question, but rather that the traditional Linnaean categories such as genus, family, and order do not actually represent any real distinctions in nature. We may choose to continue to use the words “genus”, “family” and “order” (although it is doubtful that they will be helpful) but they are conventionally defined by us to represent something useful (like ages) in a way which is so foreign to their original (and current) purpose that in fact we are not preserving the Linnaean categories at all.

8. Why classification is not important

I have now spelled out and defended two central principles of phylogenetic systematics – that higher taxa must be clades and that superspecific ranks are meaningless and should not be used. But of course these principles are controversial. While I think a system of

phylogenetic classification can be defended along exactly the grounds I have been giving, there are some powerful objections to thinking that there is just one best way of classifying the living things around us. But even accepting many of the powerful objections against phylogenetic classification, we can preserve nearly everything said so far by making a key distinction that in retrospect, is clearly an important distinction to make. That is, we can make the distinction between systematics and classification.

Simpson, Mayr, and for that matter most systematists clearly think of constructing a classification of life as a central task, if not the central task of systematics. However, this is not at all obvious. A number of sources consider the main positions in systematics to be Pheneticism, Cladism, and Evolutionary Systematics. The debates have even been termed the “Systematics Wars” and a part of this history has been chronicled by David Hull in the impressive volume *Science as Process* (Hull 1988).

But important aspects of the debate reveal that in fact inferring the phylogeny, and constructing classifications, are logically separate activities. The pheneticist simply ignores the phylogeny when building a classification. The cladist believes that once in possession of the phylogeny, a classification can be constructed from this information alone. The evolutionary systematist believes that a proper classification must take more than just the phylogeny into account – for example, the adaptive divergence of the taxa in question must be used and this information can be usefully used in the ranking system. Pheneticism, Cladism, and Evolutionary Systematics are not properly thought of as different positions of how to proceed in *Systematics*, rather, they are positions on how we ought to build our classifications.

It would seem clear that at least the evolutionary systematist and the cladist agree that the phylogeny is something essential to making biological inferences. As Mayr and Ashlock say,

“Ultimately, the deficiencies of cladistic classifications are due to the failure of cladists to appreciate the difference between the functions of a model of descent and those of a classification. Hull rightly pointed out that “biological classification cannot be made to reflect very much about phylogeny without frustrating other functions of scientific classification” (1979:437). There is no need to demand that a classification simultaneously serve as a diagram of descent. The genealogical information can easily be supplied by publishing a cladogram together with an evolutionary classification” (Mayr and Ashlock 1991: 235).

At least one significant question appears to be what the phylogeny is, and a separate significant question is how should we classify these organisms. The cladist apparently holds the position that there is nothing to classification above and beyond the genealogy (except perhaps how we choose to name the clades), but there is a distinct conceptual position from cladism which says not that the classification just is the genealogy, but rather, that there is no serious scientific question about classification at all. This view is briefly described by Joseph Felsenstein in *Inferring Phylogenies*. As he puts it, systematists “spend their time making estimates of the phylogeny and using them to draw conclusions about the evolution of interesting characters. They use phylogenies a great deal. But, having an estimate of the phylogeny in hand, they do not make use of the classification” (Felsenstein 2004: 145).

In fact, the arguments made above for the importance of discovering clades and using only clades when making inferences can be preserved *even if* it turns out that there is a better way of classifying organisms. We must simply avoid the mistake of assuming that the taxa we use for classification are the same as the taxa that we can use for phylogenetic trees. Given the importance of phylogeny, and the apparent unimportance of the classification (if it means something other than the phylogeny), Felsenstein says, “I have consequently announced that I have founded the fourth great school of classification, the It-Doesn’t-Matter-Very-Much school. Actually, systematists “voted with their feet” to establish this school, long before I announced its existence” (Felsenstein 2004: 145).

While I am sympathetic to the It-Doesn’t-Matter-Very-Much school, for our purposes, it is not essential that it be defended. Rather, what is essential is that we recognize the importance of building a phylogeny independently of the importance of building a classification. Regardless of the correct view of classification, systematics must be in the business of building and using phylogenetic trees. Perhaps classifications are important; perhaps they aren’t. Perhaps they should incorporate ranks; perhaps they shouldn’t. Perhaps they should incorporate morphological and adaptive distinctiveness, perhaps this is misleading. But regardless of the answers to these questions, it is essential to infer the history of biological groups and this means building and using phylogenetic trees. For this purpose, we must have taxa (groups that can be placed on trees) and these taxa must be monophyletic groups and it is not essential that these groups be ranked. In fact, if ranks mean anything like they were designed to mean, or even the weakened version of what they still mean today, then ranking is likely to get in the way of our goals

of understanding the pattern of descent, rather than help. Though traditionally discussing systematics would require discussing the principles of classification, this is not essential to the science of Phylogenetics, the discipline concerned with building and using phylogenetic trees.

In fact, Mayr appears to have it backwards. It is not that we should publish the classification and then if there is sufficient interest, we can easily also publish the phylogeny of the group beside it; rather, it is the phylogeny that is of primary interest in biology and if there is sufficient interest, a classification can be added on top of this information.

9. Back to the Tree of Life

In this picture of phylogenetics, our central task is simply to discover clades. We have seen that clades simply represent a branch on the great Tree of Life. We don't have to worry about classifying or ranking the higher taxa at all; we can simply discover how they are related to each other. While this certainly seems like a perfectly objective task, it depends on the idea that in fact there is one objectively correct Tree of Life. If there isn't, then what is it for us to infer the Tree?

As odd as it may initially sound, this assumption of a unique Tree has been doubted for at least two different reasons. The first is that the true history of life may not truly be tree-like after all. For example, Ford Doolittle and various coauthors (Doolittle 1999, 2000, Baptiste et al. 2004, Susko et al. 2006, Doolittle and Baptiste 2007, and many others) have done a lot of work inferring on attempting to infer what can be thought of as the "base" of the Tree and have concluded that in fact there is no true Tree at all

since there is so much lateral gene transfer that the whole of life is not properly tree-like. But a second, and potentially more devastating objection is that instead of one unique Tree of Life, rather, there are multiple, inconsistent Trees of Life. In the next chapter, I will argue that this second objection is avoided if we simply apply our phylogenetic principles consistently into the last area of systematics that they have yet to penetrate: into the realm of species themselves.

TWO

THE NEED FOR A PHYLOGENETIC SPECIES CONCEPT

1. Introduction

In Chapter 1, I argued for two key principles of phylogenetic systematics: that taxa must be monophyletic groups and that these taxa should not be ranked since the ranks do not represent any fundamental differences in nature. Systematics today is dominated by this phylogenetic perspective – the view that evolutionary history is of primary importance when delimiting taxa. Reconstructing the history of these groups – the project of phylogenetic inference – involves discovering where particular organisms fit on the Tree of Life. Because of this goal, paraphyletic groups like the traditional Reptilia, which cannot be properly placed on a tree, cannot be taxa. Similarly, polyphyletic groups such as the Birds plus the Bats, a group we might call “flying tetrapods”¹, which have no unique history, cannot be taxa.

Despite the dominance of the phylogenetic perspective in systematics today, a number of non-monophyletic taxa continue to be used in systematics; these are some of the “species” recognized by species concepts such as the Biological Species Concept, which group organisms together in ways that are incompatible with genealogical history.

¹ The pterosaurs, an extinct taxon closely related to dinosaurs, were also flying tetrapods.

The arguments in the first chapter are typically thought to be directed only at the supraspecific, or “higher” taxa. In other words, there are two types of taxa – species and higher taxa and it is the higher taxa that have to be monophyletic. As for ranking, obviously, the species are ranked taxa (ranked at the level of “species”) and it is claimed that taxa at this rank are special and the arguments of the previous chapter do not apply.

But this is incorrect. The same arguments can be given to show that species must be monophyletic groups as well. Non history-based species concepts such as the Biological Species Concept lead systematists to make the same type of errors as those engendered by Reptilia and “flying tetrapods.” These errors are not mere logical possibilities; they arise frequently in biological practice.

The goal of this chapter is to argue for the necessity of a phylogenetic species concept. I do this by arguing that a set of views and a set of practices, both widely endorsed by biologists, are incompatible. The argument is essentially as follows:

- 1) A species concept determines the parent-offspring (or genealogical) relationship between species (via its implied definition of speciation).
- 2) A phylogenetic tree represents genealogical relationships between groups and is used to make inferences about evolutionary history.
- 3) When we use a non-phylogenetic species concept, and these groups are placed on phylogenetic trees, the tree has false implications about evolutionary history.

Therefore, 4) We need a phylogenetic species concept.

Structurally, the argument is similar to the argument given in the previous chapter for why higher taxa must be monophyletic. Non-monophyletic groups do not have unique genealogical histories and if we try to place them at the tip of a tree, we will make bad inferences about evolutionary history. So they cannot be taxa. Here, the argument is specifically tailored to species and is especially powerful since it is even more clear with species than with higher taxa that they should have genealogical histories and that they should be units of phylogeny that we place at the tips of trees.

It is an unquestionable fact that a central part of modern evolutionary theory is the use of phylogenetic trees to make inferences about evolutionary history. However, in this paper I give no argument that we must place the groups we call “species” on trees to make historical inferences rather than having separate systems for classification and for use with trees. Rather, I simply point out that if we do place species on trees, as is the common practice, and we use trees to make the kinds of inferences that we typically do make, then we must have a phylogenetic species concept.

2. The Biological Species Concept

One of the earliest and most influential statements of what is now called the Biological Species Concept (BSC) is the definition given by Mayr in 1942 – “Species are groups of actually or potentially interbreeding natural populations, which are reproductively isolated from other such groups” (Mayr, 1942: 120). Many recent discussions simply drop the “actually or potentially” from the definition, including some by Mayr himself (Mayr 2000). However, Mayr and other friends of the BSC did not intend to alter the

original concept. This is clear when Mayr says “interbreeding indicates a propensity” (Mayr 2000: 17); he sees “potentially interbreeding” as redundant, not incorrect. The concept demands that different species possess intrinsic isolating barriers defined as “those biological features of organisms that impede the exchange of genes with members of other populations” (Coyne and Orr 2004: 29). Extrinsic barriers such as mountains and rivers or just simple separation in time or space may prevent actual interbreeding, but these are not the kinds of barriers that make for separate species.

The BSC has survived for decades and remains popular among biologists despite the many criticisms that have been levied against it. In their recent book *Speciation*, Coyne and Orr treat the BSC as the concept of choice among biologists. They discuss the species problem in their first chapter and describe many other concepts in the literature, but after quickly dismissing other views they settle on the BSC and focus their attention on reproductive isolation for the rest of the book.

However, rather than being a natural fit with evolutionary theory, the BSC in fact conflicts with current evolutionary thought. The BSC and its focus on reproductive isolation is a product of the Modern Synthesis forged in the 1930’s and 40’s and does not cohere with more recent advances in phylogenetics that began in the 1960’s (Baum, 1992). Many phylogenetic systematists have criticized the BSC because it distorts evolutionary history. For example, Rosen (1978), Cracraft (1983), Donoghue (1985), and Mishler (1985), all present versions of the same problem for the BSC – that reproductively isolated groups might be non-monophyletic and as such should not be viewed as taxa. Defenses against this charge have been attempted (Coyne & Orr, 2004; Harrison, 1998), but I argue that they are unsuccessful. In addition, the criticism of the

BSC discussed in this literature pinpoints only one way in which the BSC distorts history. The underlying problem can be used to generate additional and more serious objections. These objections to the BSC also straightforwardly apply to other species concepts that are not explicitly concerned with evolutionary history – for example, the Ecological Species Concept of Van Valen (1976), the Phenetic Species Concept of Sneath and Sokal (1973), the Cohesion Species Concept of Templeton (1989), and the Genetic Species Concept of Mallet (1995). Since representing evolutionary history is of primary importance in evolutionary biology, these problems show that the BSC, along with these other species concepts, are unacceptable.

3. How the BSC distorts history

I will discuss three ways in which the BSC can distort evolutionary history. The first case, which has been widely noted in the literature, is that species picked out by the BSC can be paraphyletic – i.e., they can be composed of some, but not all, of the descendants of some ancestral population.² For consistency with the literature, I follow the convention of calling the groups picked out by the BSC “biospecies” even though if I am right, they are often not actually species at all.

The other two ways in which the BSC distorts history rely on the fact that the genealogical history of biospecies is often in conflict with the genealogy of the organisms in these biospecies. This fact will be much easier to understand once we have a more

² It is also possible for a biospecies to be a polyphyletic group. But the difference between paraphyletic and polyphyletic groups depends on classifying ancestral groups which is usually ignored by defenders of the BSC. What is essential to the problem is only that the group is not monophyletic.

solid grip on the first problem. I will therefore postpone discussion of the other two problems until after we have discussed the first in some depth.

The first problem, which I call “the paraphyly problem,” is that biospecies do not always form exclusive groups. Since they are not exclusive groups, placing them on the tips of trees misrepresents history and leads to incorrect inferences. In fact, this error is more than possible; it often occurs in nature when the BSC is used. For example, start with two or more separate populations of the same biospecies. One of the populations then splits and one of the resulting lineages becomes reproductively isolated from all the others. The population tree (a tree that has populations at its tips) that results is displayed in Figure 2.1. Although A1 and A2 are historically separated groups, we imagine that there is no intrinsic reproductive isolation between A1 and A2 so they are members of the same biospecies, whereas evolution in the lineage leading to B has resulted in current members of B being unable to reproduce with either A1 or A2. B is reproductively isolated from the A’s, so the BSC entails that B and A are distinct species. Yet, the population A2 is genealogically more closely related to B than it is to A1. Thus A (=A1+A2), a biospecies, is not an exclusive group. A is a paraphyletic group since the most recent common ancestor of A1 and A2 is also an ancestor of B.

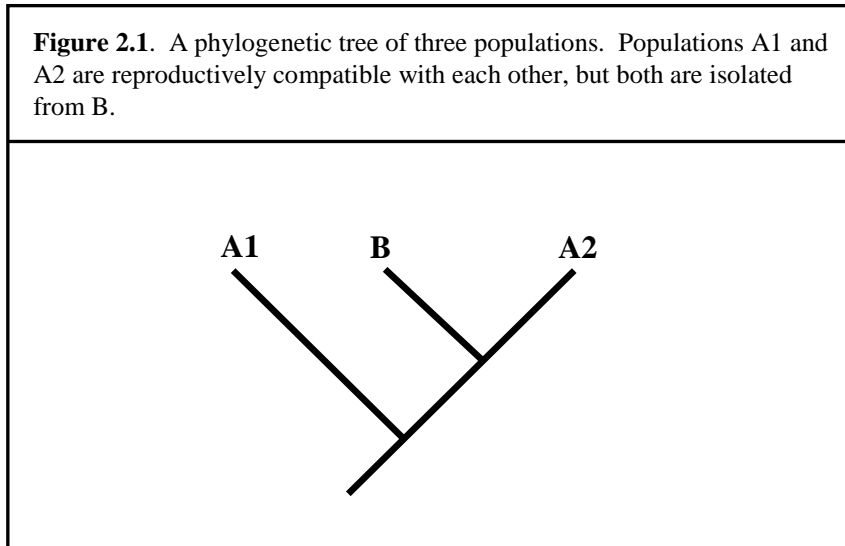

A real example of this type is supplied by two different groups of moths in the genus *Greya* (Figure 2.2). In the first case, *Greya solenobiella* is paraphyletic; in the second case, *Greya piperella* is. Harrison (1998) lists several other likely cases from the literature. In fact, when we consider current models of the evolution of mechanisms that induce reproductive isolation, it seems that not only is this kind of paraphyly possible, but that it likely occurs very often. A paraphyletic biospecies often forms when we have founder events such as a splinter group invading an island or when a parasite shifts to a new host within only one local region. Similarly, if an entire population evolves into a reproductively isolated group without splitting, as long as it was more closely related to one of the populations of its ancestral species than to any other, we again have a paraphyletic biospecies (formed from the remaining organisms of the old species).

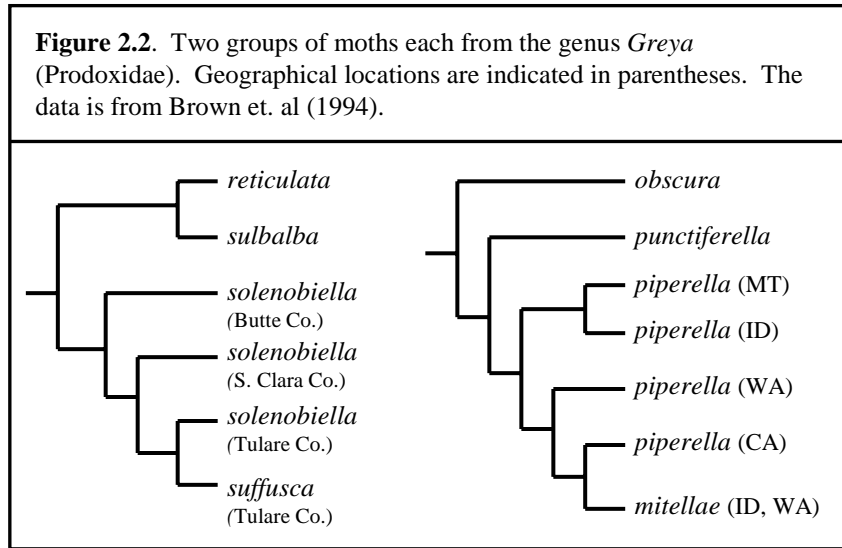

Before discussing this case, it is worth considering one common reply, which claims that it is impossible for a species to be either monophyletic or paraphyletic because these terms apply only to groups of species. The idea is that these terms apply to collections of “atoms”, but not to the atoms themselves. This claim has often been made, even by those who are not attempting to defend the BSC (for example, Wiley 1981, and Nixon & Wheeler 1990). My reply is that this point does not address the objection, but is merely a semantic point. Even if we accept the premise that these authors are relying on that species and higher taxa are simply different sorts of entities, the objection is that the BSC allows populations of one species to be more closely related to another species than to other populations in the same species. This has the consequence that species cannot be the tips of phylogenetic trees. If correct, this is a difficulty that even those who wish to restrict the terms “monophyly” and “paraphyly” to groups of species must recognize.

Abandoning the BSC because of scenarios like the moth examples above has been called “fear of paraphyly” (Harrison, 1998). The paraphyly problem stems from the fact that historical splits between groups can take place without the evolution of reproductive isolation between these groups. When the problem is put this way, it is easy to see that many other species concepts also fall prey to it. The phenomenon will occur equally, when “speciation” involves a population switching to a new ecological niche, diverging in morphology or genetic composition, or ceasing to show phenotypic cohesion with other populations.

Authors who notice the above problem tend to develop some version of what they call a “Phylogenetic Species Concept” (PSC). Cracraft (1983) was perhaps the first to use this term. His version of the concept groups species by unique patterns of shared characters and Rosen (1978), Eldredge & Cracraft (1980) and Nixon & Wheeler (1990), among others, present versions of the same idea. A recent explication of this concept defines species as “the smallest aggregation of (sexual) populations or (asexual) lineages diagnosable by a unique combination of character states” (Wheeler and Platnick 2000: 58).

Although these authors criticize other species concepts for being inconsistent with phylogenetic theory, ironically, their “phylogenetic” concept is also unsuitable for phylogenetics. Baum and Donoghue (1995) divide versions of concepts that have been named PSCs into two groups – those that are based on characters and those based on history. The version of the PSC that mentions diagnosable characters falls in the first group and, as such, suffers the same fate as the BSC for the reasons indicated above. Just as reproductive compatibility can be the ancestral state of a group of populations, a

particular character or cluster of characters may be present in an ancestral group. Then populations diverge and one of the new populations loses some or even all of these particular characters. Now two distantly related populations share the combination of traits that is said to suffice for conspecificity and so this character-based species concept also leads to paraphyletic taxa.

When we group organisms by any single property other than genealogical history, it is possible to form paraphyletic groups. It is worth noting that the recent philosophical literature on species has seen the rise of a number of defenses of pluralism about the properties that define species. For example, both Boyd (1999) and Wilson (1999) defend versions of what they call a “Homeostatic Property Cluster” view of species, while Pigliucci (2003) and Pigliucci & Kaplan (2006) defend a similar view, which they call a “family resemblance” concept. The thought is that no one property such as reproductive compatibility or a shared ecological niche is necessary for conspecificity. Since shared genealogy is explicitly declared to not be necessary either, some species grouped by these concepts will fail to form exclusive groups and therefore cannot function as phylogenetic taxa. The further criticisms of the BSC that I will enumerate apply to these other species concepts as well.

4. Responses to the parapyly problem

In responding to the parapyly problem, defenders of any of the above species concepts have only two options available: they can deny that it occurs or deny that it is a problem. The first response denies that this kind of parapyly occurs or perhaps just insists that it occurs only very rarely. But there is nothing special about the *Greya* moths case

described above. Consider the literature survey done by Funk & Omland (2003) of 584 animal phylogeny studies published in 14 journals between 1990 and 2002. Of the 2,319 species where paraphyly could have possibly been detected (it can be detected if at least two individuals from the same nominal species are selected), paraphyly or polyphyly was detected in 23% of the cases. And it has been suggested that the numbers would be even higher if plant studies had been taken into account (Crisp & Chandler, 1996; Rieseberg & Brouillet, 1994). While not every traditional species used in these studies was constructed using the BSC, many certainly were. It is implausible to claim that most of these published results are mistaken. Coyne and Orr (2004) attempt to minimize the import of these numbers, but in the end, they admit that the BSC has misrepresented real history in actual cases.

To some systematists, this represents a fatal blow to the concept, but not to all. Perhaps we should not abandon the BSC too quickly. Given the number of different properties of species attributed to them in various parts of the literature, no single concept could do everything we want. Coyne and Orr develop this reply and then attack other species concepts, arguing that the positive aspects of the BSC outweigh what they see as a relatively small problem. But Coyne and Orr then switch gears and mount the other kind of defense – namely, claiming that paraphyly might not even be a problem at all. They approvingly cite Harrison as saying, “If we accept that species are defined by isolation and/or cohesion and do not start with the assumption that they must be exclusive groups and the units of phylogeny, then including paraphyletic assemblages as species does not misrepresent history” (Harrison, 1998: 25).

An important claim being made here is that “evolutionary history” represents the history of species over time; again, species are being treated as atoms that have no internal histories. These atomistic species would by definition be acceptable as tips of phylogenetic trees and the splits leading to different species would, by necessity, be speciations. In fact, a phylogeny, and therefore a phylogenetic tree, is often defined just this way: “A phylogenetic tree is a representation of the historical course of speciation. ... It is the business of phylogenetic systematists to attempt to recover the history of speciation...” (Wiley, 1981: 2). Of course these kinds of definitions can lead to the conclusion that no species concept could possibly misrepresent the phylogeny, but with more careful wording, the idea is simply that the evolutionary history that matters is the history of reproductive isolation. This is what the BSC species tree is said to allow biologists to capture.

However, defining evolutionary history in terms of speciation events in this way is based on a fallacy. Coyne and Orr do provide a number of reasons to think that reproductive isolation is a very interesting property that we might want to study. However, nothing whatever follows about phylogenetic history. Wiley appears to reason that since we want to uncover the history of reproductive isolation, a phylogenetic tree must be a representation of this history. There are two related fallacies in this area. The first is the obviously invalid argument that because reproductive isolation is important, it must be a defining characteristic of species. But the following argument is also invalid:

1) Species are defined by the Biological Species Concept

Therefore,

 2) Phylogenetic history is the history of reproductive isolation

I will call this kind of reasoning the BSC fallacy. Other species concepts generate parallel fallacies. I will argue that it is a fallacy by arguing that phylogenetic history should be understood in a way that is completely independent of any particular theory of speciation.

I will continue to refer to the “phylogenetic tree” as the representation that tracks cladogenetic splits – splits in the actual genealogical connections among organisms that constrain the transmission of genes and phenotypic traits. This may be contrasted with the “species tree,” which tracks the history of speciation as defined by some specified species concept. In the case of the BSC species tree, it will track the history of reproductive isolation. It is often assumed that these two trees are the same, but as we will now see, that assumption is incorrect.

5. The second kind of misrepresentation

Recall that the first kind of misrepresentation of evolutionary history, the paraphyly problem, occurs when reproductive isolation evolves between one phylogenetically distinct population and all the other populations in a formerly unitary biospecies. In those cases, the BSC does misrepresent history in some respect, but the misrepresentation could be considered relatively unimportant as this does not lead to any mistaken inferences about the relationships between species, but only about the history of populations. However, the problem becomes more severe when the species trees don't just fail to inform us of important details, but positively mislead us about interspecific relationships. This happens if there are further speciation events within the paraphyletic

biospecies. This is the second kind of misrepresentation: the species tree implies a clear relationship when either there is no such relationship or there is in fact a different relationship. I have divided this second kind of distortion into two cases:

2a) The No Tree problem. We want to ask about the historical relatedness of three or more biospecies A, B, and C, but when examined carefully, this question appears nonsensical. The use of an inappropriate species concept has led to the construction of a tree when none exists.

2b) The Wrong Tree problem. We want to ask about the relatedness of three or more biospecies and the answer appears to be that A and B form a clade, but the species tree shows something entirely different. Here there is a true tree, but an inappropriate species concept leads to the wrong tree.

To see this new problem, let's add a detail to the population tree in Figure 2.1. Imagine another speciation event occurs later in one of the A lineages. Perhaps A1 has its own splinter group – call it C. As before, the earliest split, at time t_1 , occurs when the lineages leading to B and A2 split from the lineages leading to A1 and C. However, no intrinsic isolating mechanisms have evolved so the BSC species tree does not recognize the split. Then, at t_2 , B splits from A2 and becomes isolated from both A1 and A2. Now the new event which was not on pictured in Figure 4 occurs – at time t_3 , C splits away from A1 and becomes reproductively isolated at essentially the same time. This history yields the trees depicted in Figure 2.3.

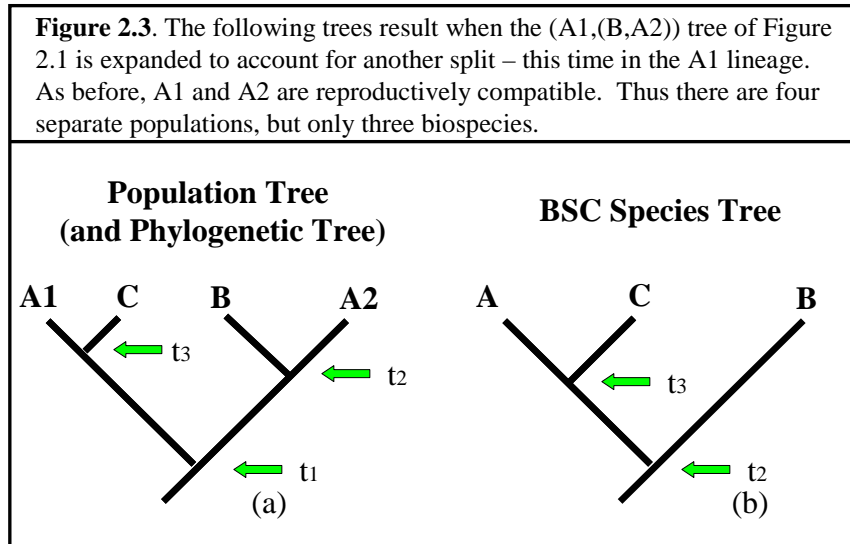

The problem with this species tree is that it implies an unambiguous relationship between the three species: A is closer to C than it is to B. In terms of biospecies and their ancestor/descendant relationships (as determined solely on the basis of speciations), this is correct and unambiguous. A and C do share a more recent common ancestor than either does with B since A and C were reproductively compatible more recently in the past (before t_3 rather than t_2). This relationship is shown in (2.3b). The problem is that in phylogenetic terms, it is incorrect to assert that A is more closely related to C than it is to B – A does not have a unique history. The population tree (2.3a) captures this important phylogenetic distinction – but the BSC species tree does not. The species as a reproductively compatible whole has a history, but individual populations within it have different reproductive histories. It would be better to say that A1 is closer to C while A2 is closer to B. Asking, “Is A more closely related to B or to C?” is asking a question with a false presupposition; it assumes that A has a unique history. But it does not. It is like

asking whether animals that can fly are more closely related to crocodiles or to primates. There is no answer – some flying animals (like birds) are closer to crocodiles while other flying animals (like bats) are closer to primates. It is a mistake to ask about the genealogy of flying animals (bird+bats) because they lack a unique genealogy. Similarly, it is a mistake to ask about the history of biospecies A, and therefore it cannot be placed on a phylogenetic tree, and so cannot be a taxon. This is the type of misrepresentation I have called “The No Tree problem.”

Misrepresentation (2b), “The Wrong Tree problem,” occurs when the species tree implies that a group has one history when in fact it has a different history. Imagine that rather than having one of the A populations in Figure 2.1 split, reproductive isolation simply evolved between A1 and A2 without any more splits.³ Here the history is just as in Figure 2.3, except that at t_3 there is no cladogenetic split, only the evolution of reproductive isolation between already existing lineages. Since it is unclear what is required for either of these populations to be the same species as before, let's simply give them both new names. A1 has evolved into C while A2 has evolved into D. Now we have the three species, C (from A1), B, and D (from A2) shown in Figure 2.4. Alternatively, we could have the split at t_3 as before and imagine that A1 has simply gone extinct. The tree would be identical.

In either of these situations, if we apply phylogenetic methods we will construct a tree with D and B forming a clade while C is more distantly related. Everything here seems correct – in fact, you might suspect that the earlier problem of a paraphyletic

³ If there are further lineage splits, the problem will still arise as soon as all of the lineages become isolated from each other.

species has simply disappeared. Not so. If we take the Wiley/Harrison line that evolutionary history is the history of speciation, then the evolutionary tree (which matches the species tree) will have C and D forming a clade – they share a more recent common ancestor. Thus the phylogenetic tree (stemming from the history of the populations, the organisms, or the genes or anything else that tracks actual reproductive links) and the species tree come apart as in Figure 2.4.

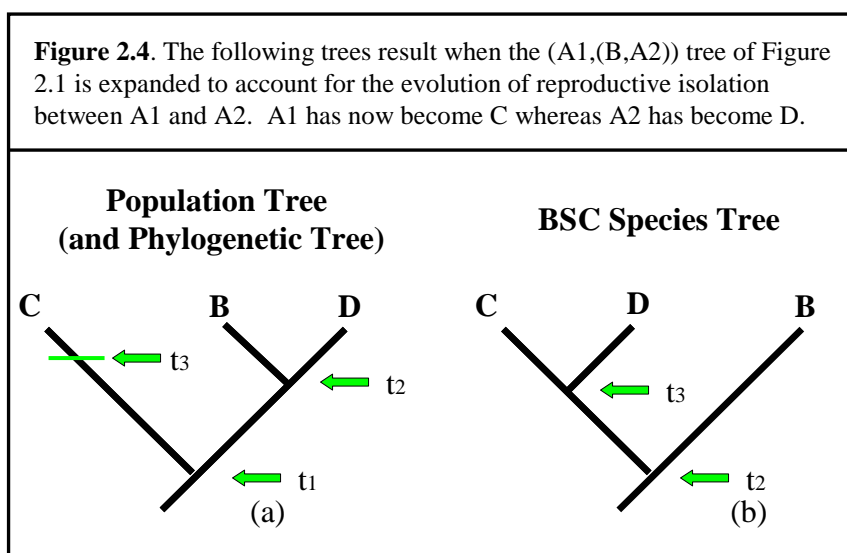

In summary, if one population out of several becomes isolated, you get a paraphyletic species. But then if another becomes isolated, you get a species tree that is either phylogenetically misleading or just simply wrong. Furthermore, the misleading case will eventually convert to an incorrect case unless the populations that make up the paraphyletic biospecies merge into a single population before any one of them acquires intrinsic reproductive isolation from any other. Thus if the BSC species tree is what we are trying to infer when we apply phylogenetic methods, it is likely that we will often

arrive at the wrong tree (since phylogenetic signal will track the phylogenetic tree) without having any way of detecting that we are making this error.

The talk of attempts to infer the species tree may make the problem seem as though it is merely epistemological. But it is not. In cases such as those in Figure 7, the BSC Species tree is simply the wrong tree as it is not consistent with the Phylogenetic tree. The obvious response is just to reiterate the Wiley/Harrison line that evolutionary history is the species history (and that the BSC is the correct species concept) and that to assume otherwise is blatantly question-begging. In the last section, I will attempt to draw out the consequences of taking this line seriously – consequences which I think are so severe that they cannot be accepted even by the most staunch defenders of the BSC.

6. Species and the Tree of Life

A few authors have noticed these problems with non-genealogical species concepts. Bremer & Wanntorp (1979) present an analogous case as a mismatch between geographic isolation and reproductive isolation, but their discussion has been largely ignored in the biological literature (but see Mishler and Donoghue 1982). In the philosophical literature, LaPorte (2005) provides similar examples showing that the BSC and the Phylogenetic Species Concept (the PSC of Cracraft 1983) can lead to different species trees. However, he then draws the wrong conclusion from this observation. Starting from the premise that there is no objective solution to the species problem, he concludes that the trees given by the BSC and the PSC are equally valid and that, therefore, there is no objective Tree of Life. As he points out, this same conclusion follows for many other species concepts.

LaPorte's article, titled "Is there a single objective, evolutionary tree of life?", centers on the idea of the Tree of Life yet he does not develop a serious discussion of just what the Tree actually is and how it is related to various species concepts. In his opening discussion, LaPorte indicates that the Tree of Life is "a single accurate branching hierarchy of species reflecting order of descent." This is a common way of understanding "the Tree of Life". However, the phrase "the Tree of Life" often stands in for a discussion of various kinds of issues. For example, we often talk of individual organisms being connected in the Tree or of gene trees as being part of the Tree. In fact, "the Tree of Life" is even used as a simple stand in for the history of all life on earth. For example, we might say that different species concept simply reflect different aspects of the Tree (Ereshefsky 2001).

Surely LaPorte would not deny that there is a single objective story of the history of life on this planet. As I will show, his titular answer of "no" relies on the combination of two mistakes: the first is a type of pluralism about species and the second is a view about how the Tree of Life is determined by our species concept.

The basic idea is simple. As argued above, different species concepts lead to incompatible groupings into species. Then different speciation concepts can lead to different orders of branching of the various "species" under consideration (as in Figure 2.4). But LaPorte is assuming a type of pluralism *about classification* which dictates that each of the groups picked out by the BSC or by the PSC really are species. Each species concept leads to a particular species tree and since these can be different, there are different Trees of Life. He then argues that since there is no reason to prefer a phylogenetic species concept to a biological one or an ecological one, then there can be

no reason to prefer the species tree represent the history of speciation according to a phylogenetic species concept over a history of speciation represented by the Biological Species concept.

On this point, LaPorte is correct – If evolutionary trees simply represent the history of speciation, then different species concepts yield different trees. However, it is a mistake to think that this is the same as concluding that the trees are equally correct. There is an objectively correct tree - a phylogenetic tree, not a species tree - because there is an objectively correct history of life. Imagine a full record of every organism and all of their ancestor/descendant relationships connected in one huge network as depicted in Figure 2.5. We can “zoom out” on the full network of individuals to look at a population which is merely a part of a larger lineage which is merely a “zoomed in” portion of a large-scale phylogeny. When we zoom in very carefully at particular portions of the phylogeny, the relationship of individuals is reticulate and does not appear tree-like. At the “nodes”, or lineage splits, there is no instantaneous separation of one lineage into two, but rather, the borders are fuzzy. However, if we are looking at a current time slice of the phylogeny, the genealogical pattern between the tips is clear. This is not surprising in the least – taking a very careful look at the borders of a material object in space – say a table – will produce equally vague results. Here, we are attempting to find the precise temporal borders of a lineage which is surely vague in precisely the same way.

Figure 2.5 Picturing a phylogeny as a summary of broad scale patterns in the full network of the genealogical connections of individual organisms.

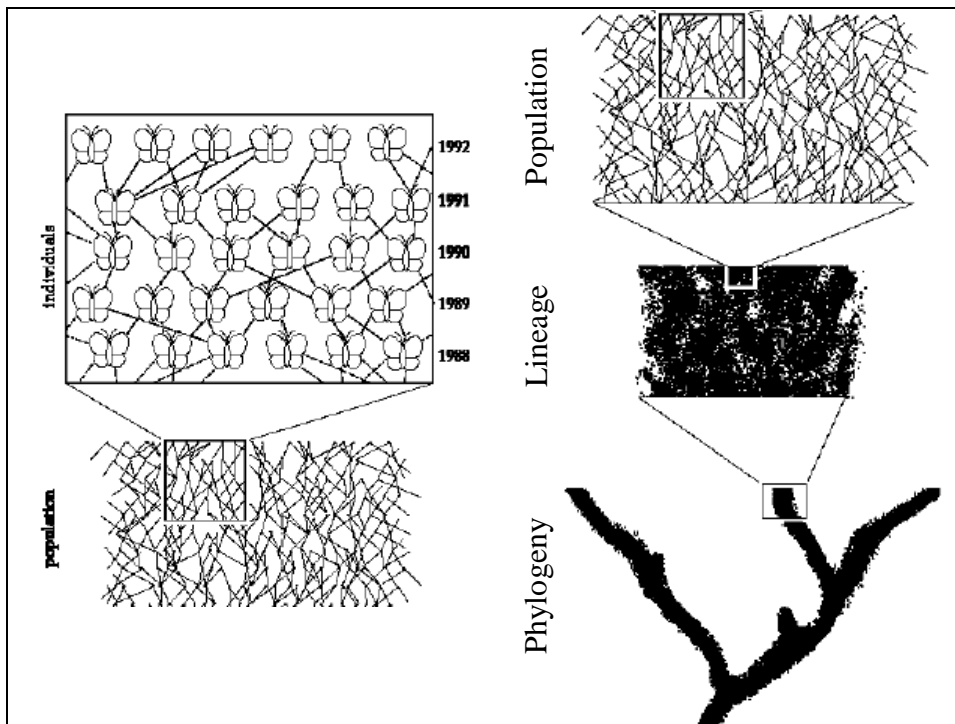

Although the full phylogeny is far too complex a structure to perfectly represent in a small picture on a piece of paper, we can attempt to summarize this full Tree (or at least those parts of it that have a tree-like structure) by placing groups of organisms into taxa and then displaying the genealogical relationships among those taxa. But the objectivity of this organismal genealogical network leaves open the question of whether organisms can be grouped in such a way that the species tree properly represents the phylogenetic tree. LaPorte assumes that the Tree of Life tracks just the history of speciation and as such, it is dependent on an arbitrary choice of species concept. However, the Tree of Life

is metaphysically prior to, and independent of, any particular species concept that we choose.

We don't create the Tree of Life; we attempt to discover it. The fact that two different species concepts lead to two different trees simply shows that at least one of these trees is wrong and therefore that at least one of these species concepts is wrong (or at least not suited for phylogenetics). LaPorte's conclusion that there is no objective phylogenetic tree is a reductio of his premise that one species concept is as good as another. I have argued that there is something that counts here, namely, that many species concepts, like the BSC, misrepresent history. It is phylogenetic history that is the appropriate focus of scientific attention and is, thus, the appropriate basis for a taxonomic system that aims to represent evolutionary relatedness.

LaPorte does not attempt to give a serious argument for species pluralism, though he certainly could by following some of the many discussions in the literature (Dupre 1993, 1999; Ereshefsky 1992, 2001; Kitcher 1984, Stanford 1995). LaPorte merely points out that of the BSC and PSC, "each concept seems to divide the organic world into groups that are natural and scientifically interesting." While this is certainly true, it is no argument that these interesting groups are *species*. Even more importantly, even if there is no fact of the matter about which groups are species, this simply does not lead to the conclusion that there is no objective Tree of Life.

The history of reproductive isolation, ecological divergence, or morphological divergence is certainly interesting, but for studies of evolutionary history, these divergences are only useful in so far as they are reliable guides to what I have called the phylogenetic tree. In fact, even if one is interested specifically in the evolution of

reproductive isolation between lineages (or one of the other traits associated with various species concepts), it is essential to first obtain the correct phylogenetic tree as a basis for understanding when various isolating traits evolved. It is a non sequitur to conclude that the BSC is correct based on the assumption that the evolution of reproductive isolation is an important problem. And even assuming that reproductive isolation does define species, this has no bearing on phylogenetic history since speciation events do not define evolutionary history. This is the fundamental problem with the BSC fallacy. Evolutionary history is not simply the history of the groups that we delineate as species. Even if we do accept that we want to study the history of reproductive isolation, we should still use phylogenetic trees (not BSC species trees) to help us recover this history.

Given the popularity of defining phylogenetic trees as species trees, an obvious response is that I am simply begging the question by calling something else the “phylogenetic tree.” Rather, on this view, the phylogenetic tree is the species tree and there is no other tree that one needs to consider. However, not only does this approach lead to the epistemological problem that our methods of inference will tend to reconstruct a tree other than the species tree, but it also leads to bizarre ontological claims. For example, phylogenetic evidence indicates that humans and chimps are more closely related to each other than either is to gorillas. But what exactly does this mean?

The “species tree” view would have it mean that the species *Homo sapiens* and the species *Pan troglodytes* share an ancestral species that is not an ancestor of *Gorilla gorilla*. But it is perfectly natural to also say that any particular human (like myself), shares a more recent common ancestor with any particular chimp than with any gorilla.

This may seem like a simple translation (or at least a consequence) of the claim about species relationships, but it is not. The claim about species relationships (for the BSC) properly translates to the idea that reproductive isolation mechanisms preventing the interbreeding of the ancestors of chimps and humans appeared more recently than did reproductive isolation mechanisms preventing the interbreeding of the ancestors of humans with ancestors of gorillas. On the other hand, the claim about organism relationships is a straightforward claim about their genealogy. A human is more closely related to a chimp than to a gorilla if the most recent common ancestor of the human and chimp is more recent than the most recent common ancestor of the human and the gorilla.

In cases of disagreement like that depicted in Figure 2.4 (which is likely to be quite a large number of cases) these two answers will be different. The following is a description of evolutionary history which is an epistemic possibility consistent with much of the evidence we have about the relationships between humans, chimps, and gorillas. In the past, ancestors of humans, chimps, and gorillas all were part of a single population. Now imagine that the branch leading to gorillas split off from the branch that subsequently splits and leads to both chimps and humans. Next, chimps develop some intrinsic mechanism which isolates them from both humans and gorillas. Lastly, isolation mechanisms develop preventing the interbreeding of humans and gorillas. For all we know, this is how it happened. Our best phylogenetic information leads us to think that we are more closely related to chimps – but this inference is based on facts such as that the genes found in humans appear to share common ancestry with chimp genes more recently than with gorilla genes. This is as it would be if the above narrative were in fact the true history. However, the above story is captured by the “Wrong Tree” problem as

in Figure 2.4 with chimps being group B, gorillas group C, and humans group D. As can be seen from Figure 2.4, if the above story is correct, the correct BSC species tree has humans and gorillas more closely related to each other than humans and chimps. If the great apes were such a case then, as a species, humans would be more closely related to gorillas, but I (and all other humans individually) would be more closely related to a chimps. This is unacceptable. Phylogenetic trees should be based on the genealogical relationships of organisms not on the order of speciation events (if species are defined in non-genealogical terms). Genealogy is what our methods track and is what common sense tells us is the intended meaning of statements about the evolutionary relations between species.

The position defended here does not deny that species have genealogical relationships to each other. Nor does it invalidate talk about the history of speciation. Rather, it holds that what we want is a species concept for which the answer to both kinds of questions is the same as answers to questions about the genealogical history of organisms.⁴ The acceptance of species concepts such as the BSC allow the formation of non-exclusive groups of organisms as taxa. I have argued that if we allow species to be non-exclusive groups of organisms, we cannot prevent clades of species (such as humans + gorillas in the above story) from being non-exclusive groups either. Not only is there an obvious theoretical tension in demanding monophyly for all taxa except those at the

⁴ Here it would be possible to talk about the genealogical history of a species “reducing to” the genealogical history of organisms, but on some ways of understanding reduction, this actually implies that species do not have a history of their own. I do not want to assert that, and clarification of the proper meaning of “reduction” in this context is not needed to make the essential point that species histories and organism histories should be consistent.

species rank, but if we delimit species in non-historical ways, we cannot prevent these non-historical connections from “bubbling up” and infecting superspecific taxa.

Species are the units of our classification system. Given that theories in systematics demand that classification be based on phylogenetic history, species must be units of phylogeny as well. Even if we want to allow non-monophyletic groups as taxa in our classification system, we still need phylogenetic units. Species play this role in phylogenetic theory. It is in this role that they are placed at the tips of phylogenetic trees and serve as units in historical inferences. We typically treat phylogenies as a record of speciation and treat clades as clades of species. But as we have seen, in order to do this, our species concept must respect phylogenetic history. The BSC, along with the other non-phylogenetic concepts that I have mentioned, fails to do so.

THREE

DEVELOPING A PHYLOGENETIC SPECIES CONCEPT

1. A Phylogenetic Species Concept

I have now argued that our species concept should not delimit groups based on non-genealogical criteria. Such a species concept would be a truly phylogenetic species concept. But I left entirely open the question of whether there is such a concept already in the literature or even whether there is any concept could meet the requirements that I lay out. For all I have said so far, it might be that any species concept will lead to groups that when placed on trees lead to false implications about evolutionary history.

When so many species concepts are inconsistent with phylogenetic theory, an obvious question to ask is which, if any, are consistent. Authors that have noticed the paraphyly problem tend to develop some version of what they call a “Phylogenetic Species Concept” (PSC). Cracraft (1983) was perhaps the first to use this term. His version of the concept groups species by unique patterns of shared characters and Rosen (1978), Eldredge & Cracraft (1980) and Nixon & Wheeler (1990) each present versions of the same idea. A recent explication of this concept defines species as “the smallest aggregation of (sexual) populations or (asexual) lineages diagnosable by a unique combination of character states” (Wheeler and Platnick 2000: 58). As I argued earlier,

this “diagnostic criterion” is not based on evolutionary history and so can lead to non-exclusive groups forming species. Thus despite its name, this concept does not fit with phylogenetic theory.

A different strain of phylogenetic species concepts has been produced with the explicit hope of co-opting the PSC name. Donoghue (1985), Mishler & Donoghue (1982), Mishler (1985), Mishler & Brandon (1987), and Mishler and Theriot (2000), each present versions of a PSC that allows only monophyletic groups to be species. This version can often lead to different groupings than the “diagnostic” line of the PSC. These concepts tend to simply define species as monophyletic groups of organisms. To do so, the definition of monophyly must be relaxed so that it is not by definition a group of species. The most recent version, Mishler and Theriot (2000: 46,47), takes its cue from Mishler and Brandon (1987) and says,

“A species is the least inclusive taxon recognized in a formal phylogenetic classification. As with all hierarchical levels of taxa in such a classification, organisms are grouped into species because of evidence of monophyly. Taxa are ranked as species rather than at some higher level because they are the smallest monophyletic groups deemed worthy of formal recognition, because of the amount of support for their monophyly and/or because of their importance in biological processes operating on the lineage in question.

Some elaboration of terms from this definition is needed (see also Mishler and Brandon 1987). *Monophyly* is defined synchronically, following the “cut

method” of Sober (1988), as all and only descendants of a common ancestor existing in any one slice of time. The ancestor is not an ancestral species, but rather a less inclusive entity such as an organism, kin group, or population that had spatiotemporal localization and cohesion/integration (as discussed in Mishler and Brandon 1987).”

There are a few things to say about their odd use of monophyly here. First of all, they describe the “cut method” of Sober 1988 as part of a definition of monophyly and they characterize it as a synchronic definition. Here is how Sober describes monophyly:

“A group is said to be monophyletic precisely when it is made of a species, all of that species’ descendants, and nothing else. What I shall call the ‘cut method’ is a useful way of understanding this property of a group. Draw a “cut” across a given branch [on a phylogenetic tree]. The species immediately above that cut and all its descendants constitute a monophyletic group” (Sober 1988:16).

It is clear from this passage, that the cut method is not the definition of a monophyletic group, but rather, an easy way to tell if a group is monophyletic when one is in possession of the correct phylogenetic tree. It is also clear that monophyletic groups are diachronic (existing through time) rather than synchronic. The mere fact that it includes both ancestors and descendents in the same group already makes this clear. A third thing that is very odd about mentioning the cut method is that Mishler and Brandon specifically want to alter the definition of monophyly from that of Sober to a definition

that allows species to be monophyletic groups of organisms. However, with this change, the cut method no longer will represent the appropriate groups since it is specifically tied to ancestral species being at the nodes of phylogenetic trees whereas Mishler, Brandon, and Theriot want to deny that species have ancestor-descendant relationships.

However, these points do not really count against their concept as there is nothing essential at all about the use of the cut method to define monophyly. But what is an important difference is that the definition of species (and all taxa) given by Mishler, Brandon, and Theriot explicitly builds in epistemological factors. On this picture, groups are not taxa because they are monophyletic; rather, they are taxa because there is strong evidence that they are monophyletic. The same considerations apply to species. Here, it seems as though the authors are concerned about why we decide to name certain groups as species, rather than being concerned with which groups really are species. After all, there are objective, mind-independent facts about genealogy that determine objective, mind-independent facts about which groups are monophyletic. So if a species must be monophyletic, then it has to be possible that we call a certain group a species on the basis of evidence that makes us believe it is monophyletic; however, that evidence is misleading and it turns out that the group really isn't monophyletic and so is not a species. However, this seems to be only a flaw in how they describe their concept, not a deep flaw in any version that might be spelled out.

It certainly seems a straightforward transition to move from taxa being clades of species to the claim that taxa, including species are clades of organisms. However, as we will see, this transition introduces a whole new set of issues. But set that aside for now –

the point is that we do not first need to delimit species in order to determine which groups of organisms are monophyletic groups. So like the phylogenetic tree, the monophyletic groups, or clades, are metaphysically prior to any particular species concept that we might have. And if we want taxa to have a unique history and to have a unique place on the Tree of Life, taxa must be clades. So if we want species to have these same properties, then species must be clades as well.

2. Monophyletic groups of organisms

The concept of a monophyletic group that is common in the literature is that it is a group of species consisting of an ancestral species and all of its descendents. I have argued that the best way to think of taxa is not as groups of species, where species is defined in some non-genealogical way, but rather, we should think of taxa directly as groups of organisms. Since we want genealogical connections between taxa that make sense of historical, causal processes that preserve heritable information, it is natural to require that taxa are related to each other in virtue of the fact that the organisms in them are genealogically related to each other in the appropriate way. Authors that have suggested this have typically seen no problem whatsoever in simply altering the concept of monophyly to one in which the ancestor and descendents that make up the group need not be species. For example, a monophyletic group of organisms might be just any organism and all of its descendents. This certainly seems perfectly straightforward and most authors have certainly treated the change as though this alteration solves certain obvious problems (such as allowing us to talk about species as monophyletic) without introducing

any new ones. However, there are serious problems with treating these monophyletic groups as species.

3. Epistemological issues

Although I will argue that there are serious problems with using monophyletic groups of organisms as species, first, I will dismiss one particular reason that this move has been thought to be inappropriate. For example, despite the fact that de Quieroz and Donoghue (1988) are clear that we should relax our understanding of monophyly to talk of such things as monophyletic groups of organisms, they later seem to argue that there are serious problems with this view.

Monophyly is, at its most basic level, a claim about genealogy. This is opposed to the pattern cladistic view where phylogenetic concepts are at bottom, claims about particular traits or characters. Of course we must acknowledge that examining morphology can provide evidence that a group is monophyletic, but that is no reason to think that morphological characters *determine* monophyly. Though de Quieroz and Donoghue clearly define monophyly in strictly genealogical terms, they still make a similar basic metaphysical vs. epistemological mistakes. For example, taking their cue from Hennig, (1966: 16-20) they claim, “It is inappropriate to inquire about phylogenetic relationships among actually interbreeding organisms, because here the pattern of relationships is not a nested hierarchy” (de Quieroz and Donoghue 1988: 325).

Although it doesn't appear to be epistemological in nature, we will shortly see that the driving force behind this objection is tied to evidence.

From this statement alone, it is unclear precisely what they mean. They say that it would be ‘inappropriate’ to inquire about phylogenetic relationships. There are plenty of reasons something might be inappropriate, for say practical or ethical reasons. But the context here is surely that it would be biologically inappropriate meaning that the appropriate concepts (here phylogeny and monophyly) simply don’t apply. However, the reason that they give is that the pattern of relationships is not a nested hierarchy. It is true that nested hierarchies are interesting patterns of relationships to examine, but they are certainly not the only possible relationships. Plant groups in which hybridization is extremely common or bacterial groups where horizontal transfer is common still form relationships, they are just difficult to figure out. The fact that humans can trace family trees shows that it is not impossible. There are still objective facts about the phylogenetic relationships about individuals even if they don’t form a proper nested hierarchy. So the mere fact that they don’t form a nested hierarchy isn’t a reason that phylogeny simply is an inapplicable concept.

While we certainly can’t conclude that non-nested genealogical relationships just don’t exist, de Quieroz and Donoghue could mean something slightly weaker such that non-nested genealogies are inappropriate to examine for some other reason. Wheeler and Nixon (1990), Nelson (1989), and others agree arguing that there is a fundamental difference between what they call phylogenetic relationships (between species) and tokogenetic relationships (between organisms). Although they claim to be following Hennig by making this distinction, their understanding of phylogenetic relationships partially stems from an understanding of species that Hennig did not hold – the view that “species are the smallest terms analyzed by cladistic methods” (Nelson 1979, Wheeler

and Nixon 1990: 77). By “cladistic methods” they mean parsimony which uses synapomorphies (shared derived traits) to judge relationships and assumes a tree-like branching structure. De Queiroz and Donoghue (1988) seem to share this view when they say,

“Phylogenetic methods break down in this case [the non-nested case] because an assumption underlying the principle that shared, derived characters provide evidence of phylogenetic relationship (i.e. of monophyly) is violated. Thus in the case of sexual dimorphism, grouping by shared derived characters may lead to the false conclusion that males (for example) within a population of interbreeding organisms form a monophyletic group. The problem in this case is that sex-linked traits of the males are being interpreted as synapomorphies at the wrong level, a fact that would become evident upon examining the distribution of these traits among parents and their offspring” (de Queiroz and Donoghue 1988: 325).

This appears to be the real reason that De Queiroz and Donoghue are claiming there is no such thing as phylogeny at the organismal level. Because the assumptions of the methods that we use break down. However, a cursory examination of the situation shows us that this is only an epistemological problem. That is, the argument seems to be that we can't determine phylogeny in the way that we typically do, therefore it is inappropriate to inquire about phylogeny. This is a bad argument. It is inappropriate to inquire *using the methods that we typically use*, however, this is far short of what is needed – namely, there is no possible way to fruitfully investigate. Many pattern cladists (such as Wheeler and Nixon) would certainly think that much follows since they claim that methods such as

Parsimony are the only way to inquire about phylogeny, but this is surely wrong (I will deal with issues of methodology in Chapter 5). But even granting this extreme conclusion, we still don't have the ontological conclusion that the concept of monophyly doesn't apply. Even if it was actually impossible to know the relevant phylogenetic relationships, that doesn't mean there aren't such relationships. Saying that the concept of monophyly doesn't apply to individuals certainly sounds like this stronger ontological claim which we now see is completely unjustified.

4. The real problem with non-nested groups

Although the fact that non-nested genealogical relationships might require different methods of inference than nested relationships require is no reason to doubt that metaphysical concepts such as monophyly do not apply to groups of organisms, the issues raised above might be the beginnings of a more serious argument about why monophyletic groups of organisms may be unsuitable as species or as taxa more generally.

In Chapter 1, I discussed the importance of monophyletic groups and exclusive groups. In a purely diverging genealogy, exclusive groups are formed from any time slice of any monophyletic group. Here the concepts fit together nicely. But the genealogies of organisms are not purely diverging. Many organisms have two parents meaning that their genealogies will be reticulate. There will therefore be a separation between those groups that are monophyletic and those that are exclusive. The problem was there before with higher taxa (for example, when taxa are formed by hybridization),

but looking at groups of organisms brings the relevant issue to light in a way that makes them more easily appreciable.

A diverging phylogeny forms a tree – branches split off from each other but never merge. This will be the case if species always have exactly one immediate ancestor. In this respect, uniparental organisms form a genealogical tree in exactly the same way that taxa do. However, biparental organisms do not form a tree. This means that monophyletic groups will overlap and therefore will not form exclusive groups. For example, I am part of one monophyletic group stemming from my paternal grandfather consisting of him and all of his descendants. I am also part of another monophyletic group consisting of my maternal grandfather and all of his descendents. These groups overlap (my two sisters and I are part of both) and neither group is exclusive. Figure 3.1 depicts part of a rather ordinary human family tree.

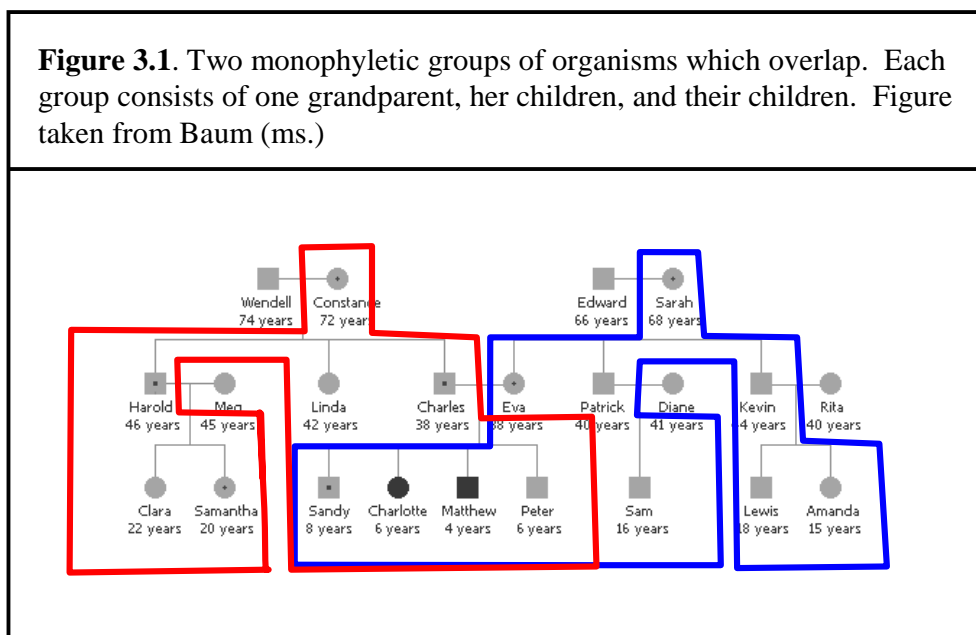

In this figure above, the two enclosed groups each represent monophyletic groups, but the organisms within each monophyletic group at the bottom (in the same generation) do not form exclusive groups. For example, Clara and Sandy are first cousins since they share a grandparent. But Sandy is also a cousin to Amanda who is outside the left hand group. If we want to turn “equally close to someone outside the group” into “more closely related to someone outside the group”, imagine simply starting the monophyletic group one generation earlier so that the shaded region now includes second cousins while a first cousin through the other parent would be outside of the shaded group.

Monophyletic groups of organisms are still interesting groups even if they overlap and are not exclusive— for example, if we are interested in tracking the history of some genetic trait, we may want to know all of the descendants of some particular person. A common example is tracking the recessive gene for hemophilia in the European royal families which requires us to have a pedigree containing at least Queen Victoria and all of her descendants. Not all of her descendants carry the relevant gene, but this would be the group to examine if you were interested in tracking it. The fact that this group overlaps with other monophyletic groups is irrelevant. But the issue here is that there are good reasons not to have overlapping taxa so we can’t simply define all monophyletic groups as taxa. What we need is to shift the discussion from monophyletic groups to exclusive groups.

5. From monophyly to exclusivity

An exclusive group of organisms is a group of organisms that are all more closely related to each other than to any organisms that are outside the group. There is no reason to

expect that all of the descendants of some particular ancestor will form an exclusive group, so we need a more careful definition of exclusivity rather than just relying on monophyly.

On a natural understanding of “more closely related”, an organism is at least as closely related to one of its parents as to any other organism. But this would require that any exclusive group that contains me must also have my father and therefore his father, and his father, etc. eventually leading to all of life forming one big exclusive group with no exclusive groups inside it. To avoid this consequence, we talk only about contemporaneous groups or relatively contemporaneous – perhaps we can include all living humans, but the point is that some ancestors must be excluded from the relevant comparison classes. This is what Baum and Shaw (1995) define as a “time-limited” rather than a “time-extended” approach to taxa. Baum (1998) describes how we could start with the time-limited approach to taxa and attempt to construct time-extended entities out of them. But as Baum points out, under almost any definition of species, we will need to be able to delimit a time-limited species in order to construct a time-extended species out of it, so there is nothing particularly surprising or undesirable about being forced to make this move.

So how do we measure how closely organisms are related to each other? An obvious way to do it is to measure their recency of common ancestry. A is more closely related to B than to C if the most recent common ancestor (MRCA) of A and B is more recent than the MRCA of A and C. This definition is applicable in both reticulating and diverging cases. However, we do have to be a bit more careful here since in a reticulating network, certain symmetries disappear – for example, unlike on a

phylogenetic tree, just because A is closer to B than to C does not follow that B is closer to A than to C. For example, in the earlier Figure 3.1, while Clara is closer to Sandy than to Sam, it is not true that Sandy is closer to Clara than Sam.

We can then extend this recency of common ancestry idea to include more than three organisms. Take some contemporaneous group of organisms X. For some subgroup A of X to be exclusive (relative to X) is for any organism in A to be more closely related to any other organism in A than to any organism in X that is not in A. This is a kind of pairwise exclusive definition where the relevant common ancestor of each pair might be different, but there are also reasons to single out groups that can be defined by talking about the MRCA of the entire group. This definition would be slightly different where an exclusive group is a group A in X such that there is some organism B who is an ancestor of every member of A and who lived more recently than the MRCA of anyone in group A with anyone in X but not in A. Notice that since B is the MRCA of every organism in A, A must include every contemporaneous descendant of B (any descendant of A would be equally closely related) and so in addition to being exclusive, these groups are timeslices of monophyletic groups of organisms.

On either of these definitions (and any reasonable definition of exclusivity), exclusive groups form a strict nested hierarchy. This is because it is impossible for groups to overlap – if an organism is part of two groups X and Y, either X is completely contained in Y or Y is completely contained in X. Imagine otherwise. Then there would be three organisms a in X, but not Y, b in X and Y, and c in Y but not X. Now since X is exclusive, b has to be closer to a (in X) than to c (not in X). Since Y is exclusive, b has to be closer to c (in Y) than to a (in X). This is contradictory, so there can be no such

overlap. Notice that this has nothing to do with X or Y being basal groups so higher taxa exhibit the same non-overlap property and therefore exclusive groups form a strict hierarchy which is a very desirable, if not necessary condition on a definition of taxa.

It may now seem that we can treat this MRCA for a group as phylogenetically representing the whole group, but this is not so. Organisms in different groups could still be connected to each other through lines of descent other than through this MRCA. This means that although group A is exclusive, some organisms outside A could be closer to some organisms in A than to others. This is undesirable for reasons explained in Chapter 1. Although group A could fit the definition of exclusivity, it doesn't have all of the nice properties previously ascribed to exclusive groups (which we can now see should have been ascribed to exclusive groups in a purely diverging phylogeny). A true genealogical unit should be such that it is "collapsible" and can be treated like a single point with respect to every other part of the Tree of Life.

We could guarantee this "unity" condition where any organism outside of an exclusive group is related equally to any organism within with another restriction on exclusivity. In order to require that this MRCA of the group cannot be avoided in a genealogical line leading to the exclusive group in question, we could demand that the MRCA of the group be a "bottleneck" organism such that any ancestral line that reaches anything in A must go through this organism. But this is far too restrictive. Exclusive groups of this type would rarely form in sexually reproducing lineages. But we can ensure the unity condition without resorting to bottlenecks by simply requiring that there be some path through the MRCA. Now our definition is as follows: an exclusive group of organisms A is a contemporaneous group taken from a larger contemporaneous group

X such that there is some organism B where B is an ancestor of every organism in A and B is a descendent of any common ancestor of any member of A and any member of X not in A.” This is equivalent to the definition of exclusivity given in Baum (ms).

Notice that officially, there is no need to require that the relevant organism B actually be the MRCA of all of the organisms in A. We still get the unity condition and everything else we want if there is some other common ancestor slightly further back in time who meets the other definitional criteria.

As an example, let’s describe what it means for extant humans to be an exclusive group. Let’s call contemporaneous organisms the set of all organisms alive today. For the living humans to form an exclusive group, there must be some organism B such that B is an ancestor of all living humans and is a descendent of any common ancestor of a human and a non-human. So for example, any chimp and I share a number of ancestors in common with the most recent probably having lived around 6 million years ago, and B must be a descendant of each of these. If this is the case, then all humans are more closely related to each other than to any non-human, and any non-human is equally related to every human.

We have good reason to believe that humans are an exclusive group under just such a definition. For example, Mitochondrial Eve, estimated to have lived about 140,000 years ago (Dawkins 2004) is the maternal line ancestor of every living human (trace back mother to mother to mother, etc. and you will hit Mitochondrial Eve) and Y-chromosome Adam is the paternal line ancestor of every human, estimated to have lived about 60,000 years ago. Incidentally, the MRCA of all living humans (through mixed male and female lines) is estimated to have lived much more recently – estimates vary

from 8,000 to as little as 2,000 years ago (Chang 2004, Rohde et al. 2004, Rohde submitted). This seems remarkable recent, but in fact compared to other comparable groups of organisms, it is relatively distant due to the obvious separation of large groups of humans from each other. In a randomly mating population of n individuals, the predicted time to the MRCA is heavily concentrated around $\log_2 N$ generations so that for example, in a population of 1,000,000 humans, one would predict that the MRCA would have living approximately 20 generations earlier. It is not difficult for exclusive groups of this type to form given a reasonable amount of time isolated from outside groups.

We can also be sure that our exclusive groups will exhibit the unity condition if they at any time exhibit what is called an “identical ancestors point”. The identical ancestors point (IAP) is that point in a given population's past where each individual alive turned out to be either the ancestor of every individual alive now, or to have no living descendants at all. If a population has such a point, then the population can truly be thought as a unit since no organism outside it could be differentially related to organisms inside it.

If going back through time a population hits an IAP, we can be sure that at any earlier time, the population will continue to have this property since if any organism has a living descendent, it must have a descendent at the IAP which is an ancestor of every living organism in the group. This point will typically lie further in the past than the population's MRCA, but this would allow us to avoid the requirement that any particular organism form a bottleneck (although probabilistically, it is very likely that many such organisms will do so). For humans, the IAP is currently estimated to be 15,000 and 5,000 years ago, but like the MRCA, it is a moving target. As isolated lineages in the

population go extinct or merge, the relevant point in time will continue to move later and later. For example, there may well be tribes of humans who have been isolated from the outside world for thousands of years who may share common ancestors with other human populations only deep in the past where the MRCA of all humans lies. But if this population were to die off, the MRCA of all extant humans might be someone who lived more recently than the split with this now extinct population. A small amount of immigration into the isolated population will take slightly more time, but eventually all members of the isolated group will be descendants of some immigrant or other and again the MRCA can shift to become more recent. Certainly it can never move deeper in time.

While it may seem that we have an overly complicated definition of an exclusive group, it turns out to be difficult only to spell out the proper genealogical relations, not difficult for such relations to arise. Two isolated lineages are virtually certain to form exclusive groups in a biologically reasonable amount of time ($\log_2 N$ generations for a randomly mating population, longer if there is strong assortative mating). Exclusive groups of organisms certainly seem to be genealogical units of the relevant sort. Their genealogical connections with each other are grounded in the genealogical connections of organisms which provide the mediums to transmit heritable information through time. Since they are time-slices of monophyletic groups they can function in historical explanations of trait distribution and since they possess the unity condition they can be placed at the tips of phylogenetic trees in order to function as a part of history-based inferences in evolutionary biology. In short, they fulfill all of the desiderata of the units in phylogenetic systematics and so exclusive groups of organisms can and should be equated with taxa. These taxa have the property of being located at a precise place on the

Tree of Life. Though there is still room for debate about precisely how to construct time-extended entities out of these time-limited entities (Baum 1998), these exclusive groups of organisms have the properties that we need for our building blocks.

6. From organism pedigrees to gene genealogies

I have now spelled out a genealogical species concept according to which the genealogy of a species is completely determined by the genealogy of the organisms in the species. This “reductive” understanding of species gives us a picture of what taxa are, sets the metaphysical stage that allows us to have a concept of the genealogy of taxa, and gives us a picture of one possible meaning of “the Tree of Life”. But there are serious limitations to this picture. Even granting the necessity of a genealogy-based Phylogenetic Species Concept, this might not be the best version of such a concept.

Previously, we have seen that looking at the history of organisms rather than some higher level “species history” improves our picture of how it is that we can understand genealogy. Many traditional concepts of species do not seem to apply across the whole of the Tree of Life. For example, many systematists doubt the existence of species in Bacteria, yet phylogenetic studies of Bacteria are completely standard. This research can be understood as attempting to replace the goal of finding a species history with the goal of finding the history of organisms. Another issue is that many traditionally recognized species seem to have multiple histories because these groups are paraphyletic or even polyphyletic groups of organisms. Again, the move to searching for the history of groups of organisms seems to make these problems dissolve because the genealogy of each organism is objective and we have defined taxa in such a way as to ensure that they have

the unitary property and so have a single united history even if we may have epistemological difficulties recovering it.

But in fact, organisms are not the panacea that this view makes them seem to be. It is not obvious that the concept of “organism” applies everywhere that we could do phylogenetic studies. For example, a famous phylogenetic study of varying strains of HIV was used by the CDC to prove that a Florida dentist was passing the virus onto his patients (Palca 1992, Smith and Waterman 1992). However, if organisms must be able to reproduce relatively independently of other organisms, then viruses will not be organisms and there is no organismal history here that permits one to make sense of the phylogeny. While it is by no means clear what sufficient and necessary conditions there might be for being an organism, many of the proposed definitions will leave viruses out (Wilson 2005).

More general concerns about what organisms are threaten to undermine their usefulness for phylogenetics. For example, we could ask whether or not a human organism includes its gut flora (the trillions of microorganisms that live in our digestive tracts). Symbiotic relationships such as these are widespread through all branches of life (Wilson 2005). If organisms are defined in terms of some type of functional/causal dependency, then surely gut flora are part of the human organism. But in this case, an organism does not have a single genealogy, but rather, has many parts which have different genealogies. An obvious way to attempt to remedy this is by defining organisms (or at least organisms for the purpose of our definition of taxa) in such a way that the gut flora is made up of trillions of different organisms, each with its own genealogy and the human organism has its own separate genealogy. The natural way to

do this is to identify an organism (or an organism's genealogy) with a token genome.

An intestinal bacterium has a separate genome from its host's genome, so they are separate organisms.

Since an organism as a biological entity is obviously more than just its genome, thinking about organisms as parts of taxa and the role that their genealogy plays in taxonomy leads us to the view that genealogy of genomes is in some sense more fundamental for phylogeny than the history of "whole" organisms in the more conventional sense of the word. This transition is what allows us to see what might be thought to be a devastating problem for the organism view of taxa – genomes themselves do not have unique genealogies. Just as species are composed of organisms that have different genealogical histories, organisms themselves have parts (different genes) that have different genealogical histories

Just as organisms have genealogies, genes also have genealogies. Any token copy of a gene in some individual has the DNA sequence that it has because it inherited it through replication from some "parent" gene. Going back through many replication events, we eventually get to genes that were located in a different individual (usually a parent). If we examine two token copies of a gene (whether in two different individuals or in the same individual) they share a common ancestor in the past which is called the point of coalescence. The study of gene genealogies within a population (or set of taxa) is called coalescent theory and has come to be a large part of modern population genetics (Hein et al. 2005). Exactly how the genealogy of genes relates to taxonomy is the subject of the remainder of this chapter.

7. Gene genealogies

It is easy to see that different genes in an organism can have different histories. In purely asexual organisms, the entire genome is passed on from parent to offspring and so all genes will have concordant (identical) histories. But in biparental organisms, the genome is made up of a set of genes, a subset of which came from each parent. In the case of horizontal gene transfer, a subset of genes are be passed from one organism to another without this involving an act of reproduction. Like sexual reproduction, this also causes different genes in the same genome to have discordant (non-identical) histories.

If homologous genes are sampled from two organisms, we can ask “How far back in time do these genic lineages coalesce?” The more recently they coalesce, the more closely related the genes are. So we can say that a gene copy A is more closely related to copy B than it is to copy C if A and B coalesce with each other more recently than either does with C. This is completely analogous to the case of common ancestry of uniparental organisms. Since genes here are, by definition, non-recombining genetic elements, each gene has a unique genealogical history and gene genealogies form strictly divergent branching trees.

Figure 3.2 represents the history of a number of copies of a homologous gene present in a number of individuals in a population. Here, the organisms are diploids, meaning that they have two copies of each homologous chromosome represented by two connected circles. By convention, the left circle represents the maternal copy of the gene. The vertical lines are lines of gene descent from parent to offspring. For example, the organism in the bottom left passed on a maternal copy of the gene (and so is female) to

one offspring (a male) who in turn passed on his paternal copy of the gene to his daughter. Some organisms pass on multiple copies of the gene while others pass on none – whether they have any organismal offspring at all cannot be determined from the diagram.

Figure 3.2 A population of organisms with the history of a single gene highlighted. The organism pedigree is from Maddison (1995).

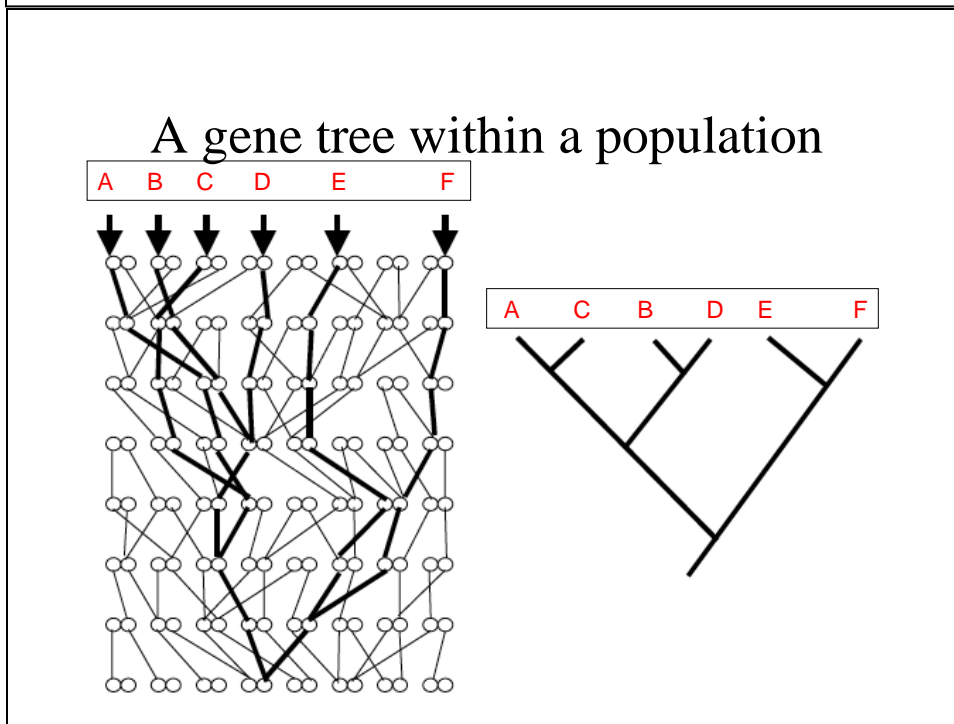

The lineages in bold represent a single token gene and all of its descendants as they spread through the population. If we sample a number of copies of this gene at the tips (A-F) they will form a tree based on their times of coalescence with the other tips. In this case, token copy A is more closely related to token copy C than to token copy B since A and C coalesce one generation earlier. Since each gene has only one parent, gene

genealogies are purely diverging trees. If we continued to extend this population back through time, eventually we would get to a point where we could trace the history of all 16 copies of the gene at the present time back to their MRCA.

Within the same population of organisms, different genes form different trees. For some genes, my sister and I have copies that coalesce in one of our parents. For other genes, they coalesce very deeply in the past. So the full network of organismal genealogies does not determine any of the gene genealogies. Not every genetic lineage goes through the most recent common ancestor of two organisms. But if phylogenetic trees are to be useful for tracing the history of traits and traits are at least partially determined by gene histories, then knowing only the organismal histories (and only a fraction of the organismal history when we are basing our taxa only on MRCAs) we will not fully understand the history of heritable traits. Knowing only about recency of common ancestry at the organismal level provides only an incomplete genealogical history.

While it is obvious that different genes have different trees *within a population*, what is not obvious is that different genes indicate different relationships *between populations*. In many cases, two copies of a gene in a single population will coalesce before that population split from another. But this means that a copy of a gene is often more closely related to a copy from another population than from some copies in its own population. And "population" is just a placeholder here – this kind of non-exclusivity extends above the level of the traditional species causes gene copies in one species to be closer to copies in another species than to other copies in its own species. If the time to coalescence extends past two speciation events, then we can have gene discordance at the

level of species histories. For example, it is possible that if we sampled a gene from a human, a chimp, and a gorilla, the expectation is that the genes from the human and the chimp would coalesce more recently with each other than either does with the one from a gorilla. But because some gene coalescent times are very different than others, some genes will exhibit different histories than this – some genes will indicate that humans and gorillas form a clade and others will indicate that chimps and gorillas do. This is possible even if we have defined human, chimp, and gorilla in a way that guarantees that the organisms in each form exclusive groups.

Figure 3.3 displays an example of how gene trees can indicate different relationships than the species trees.

Figure 3.3 A, B, and C represent separate taxa as determined by recency of common ancestry of the organisms in them. The thick branches contain lineages and the skinny black lines highlights a single gene's history where the token copies from A and B coalesce more recently than either does with C.

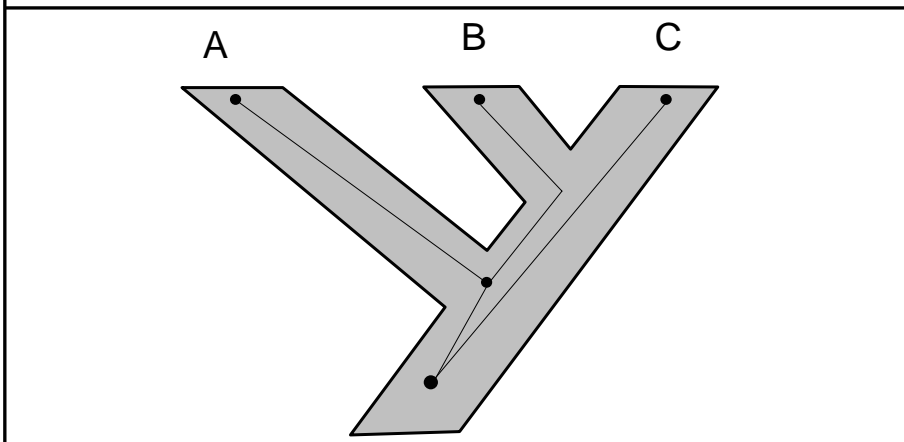

In this case, the "fat branches" represent organismal histories while the single dots represent token copies of genes and the skinny black lines are the genic lineages. In this case, while the organisms at the tips in C are more closely related to those in B than to those in A, this particular gene shows a history where A and B form a clade and C is the more distantly related.

Since the 1980's, this phenomena has become widely known and studied and is typically referred to as the relationship between gene trees and species trees (Tateno et al. 1982, Hudson 1983, Tajima 1983, Wilson et al. 1985). Since gene sequences are the primary evidence used to infer phylogenies of taxa, at the very minimum this presents an important epistemological issue in attempting to infer phylogenies. If we simply sampled one copy of a homologous gene from a number of taxa, even if we were able to correctly infer the phylogeny of the gene, the gene need not have the same phylogeny as the taxa we wished to study. The problem is not restricted to genes per se either. Imagine the simplistic case where a phenotypic character is completely controlled by one gene. This means that the character distribution represents misleading data, but not because of convergence as is typically assumed, but because the branching history of the character really is just different than the branching history of the taxa.

While this epistemological issue cannot be avoided, it might be thought that this is a purely epistemological issue. Genes have genealogies just like organisms, populations, species, and taxa have genealogies and the genealogical relations at these varying levels are just different. But there is another possible response which is that in some important metaphysical sense, gene genealogies should affect the way that we understand the genealogy of these larger groups in a way such that these are not truly independent levels.

As Maddison (1995) puts it, "one possible interpretation of a species phylogeny is that it depicts the lines by which genetic information was passed *and nothing more* (Maddison 1995: 285). Maddison interprets Baum (1992) and Baum and Shaw (1995) as holding this position although it is not clear that this is right.

On this view, a species phylogeny is composed directly of gene trees and while we still group species by some independent criteria, the genealogical relations among these species is not a single branching pattern but rather is composed of a number of branching patterns. A species tree is thus a "statistical distribution" of gene trees which might be conveyed by something like "most of the genes of species B are more closely related to the genes of C than they are to those of A, but 12% of the genes of B are more closely related to those of A and 12% of the genes of C are more closely related to those of A" (Maddison 1995: 285). In the end Maddison rejects this view because it "views populations as just bags of genes that happen to have been entangled in their history" (Maddison 1995:286) though he is a bit more favorable to the view in Maddison (1997).

While this is a rather stark view of the nature of populations, species, or taxa generally, Maddison does point out the benefits that this view has for thinking about phylogeny. For inferences that rely on phylogenies, we are concerned with the actual, historical distribution of traits (like genes) and facts about what could have potentially happened but didn't actually happen are irrelevant. What Maddison fails to realize is that we can have these properties of phylogeny without relying on the stark metaphysical picture which says species are just collections of genes. We can still define taxa as groups of organisms; we just need to understand phylogeny in a way that takes gene genealogies into account.

8. Exclusivity as recentness of genetic coalescence

We have already argued that we should think of taxa as exclusive groups of organisms. That is, groups of organisms that are more closely related to each other than to any organisms outside the group. A natural way to define how closely related two organisms are is in terms of their recentness of common ancestry. But we know that not all of our genes come from that common ancestor. So perhaps we need to have a broader understanding of genealogical relatedness that takes this into account. For example, on the MRCA view, siblings are closer than first cousins because they share a parent rather than a grandparent as their MRCA. But notice that only one parent is required. On this view, a half-sibling is equally close as a sibling. But another natural way to think about the situation is that full siblings are more closely related than half-siblings because they share *two* parents, not just one. A natural translation of this fact that you would find in an introductory genetics text is that half-siblings are expected to share 1/4 of their genes whereas siblings share 1/2¹. With more distant relationships, it becomes more obvious that we may be more concerned with trying to combine the history of a number of our ancestors rather than simply being concerned with a single ancestor in common who happens to be the most recent of all of a large number of distinct common ancestors that we might share.

¹ “Sharing 1/2 of their genes” is a common way of expressing a particular relationship that is very difficult to describe. With siblings, it is equivalent to claiming that the expectation is that 1/2 of their genes will coalesce in one or the other of their parents whereas with half-siblings, 1/4 of their genes are expected to coalesce in a parent. But this type of translation becomes difficult when we say that for example, siblings whose parents are themselves cousins share 9/16 of their genes (of the 50% of their homologous genes that come from different parents, 1/8 of them will be shared between the parents since they are cousins so $1/2 + 1/8 * 1/2 = 9/16$).

Gene relatedness now provides us with an obvious way to measure relatedness that can come apart from recency of common ancestry – relatedness in terms of gene genealogies. Since different genes have different histories, we will have to think of the organism's genealogy as some sort of combination of gene histories. This takes into account the idea that not all of an organism's genes are passed down from a single ancestor.

One way of doing it is to alter our understanding of an exclusive group of organisms. The definition used earlier in the chapter is that an exclusive group of organisms is a group that shares an ancestor that is a descendant of any organism that is a common ancestor of any organism in the group with any contemporaneous organism outside the group. But we could also define exclusivity in terms of gene histories. Baum and Shaw (1995) define an exclusive group of organisms as one whose genes coalesce more recently within the group than between any member of the group and any organism outside the group.

This definition does seem to implicitly define exclusivity as what we might call "100% exclusivity". This definition has a number of interesting consequences. One is that since gene trees are strictly diverging, we can be sure that exclusive groups really are collapsible and will have the unity property just as our previous definition had. The phylogenies of a number of exclusive groups will form a strictly diverging tree. Another interesting consequence is that it removes the possibility of gene trees disagreeing with "species trees". If you do have a gene tree that disagrees with what you thought the species tree was, either you have inferred the gene tree incorrectly, or you are mistaken about which groups form species.

These 100% exclusive groups have a number of very useful properties from the standpoint of phylogenetics precisely because their definition entails that they conform to a precise nested hierarchy. But we have not gotten rid of the discordance among gene trees – rather, all we have done is shifted the border between interspecies relationships (the diverging ones which are traditionally in the realm of systematics) and intraspecies relationships (the reticulate ones which are traditionally outside the realm of systematics.) Rather than recognizing that the border between strictly diverging and even somewhat reticulate does not lie where we have traditionally thought of species, Baum and Shaw have simply defined species as being precisely at this border. But as we will see, despite its nice theoretical virtues, this view is simply too radical in its consequences concerning which groups we should call species.

9. From 100% to less

Requiring of an exclusive group that *all* of their genes coalesce more recently with each other than with any outside genes is a very stringent requirement. While it is true that if two populations are isolated long enough, drift alone will eventually lead to each being exclusive with respect to the other, achieving this "reciprocal exclusivity" can take a very long time. Some polymorphisms may be under balancing or frequency dependent selection, meaning that there will be pressure to keep two different types of alleles in the population. As long as the polymorphism persists, that gene will not show exclusivity.

These polymorphisms often exhibit coalescent times well past conventionally defined borders for species. For example, the major histocompatibility complex (MHC) is a large gene family that plays an important role in the immune system and can be

found in most vertebrates. These genes contain the most extreme examples known of genetic polymorphisms in humans with the HLA-A, HLA-B, and HLA-DRB1 genes having roughly 250, 500, and 300 known alleles respectively. Many possible explanations exist for how such extreme diversity could exist such as a response to frequency dependent selection driven by pathogens that will typically evolve in response to the most common forms of the host so uncommon forms have a selective advantage. But the precise explanation does not matter here – what matters is that many of these polymorphisms are ancient, having existed for millions of years. For example, Figueroa et al. (1988) and Lawler et al. (1988) show that many of these polymorphisms predate the split of chimpanzees and humans, meaning that some human copies will be closer to chimpanzee copies than to other human copies. This means that if we enforce 100% exclusivity requirements, humans and chimps will have to be the same species. Ayala and Escalante (1996) suggest that some could be far older – perhaps as old as 30 million years as some human alleles appear to be more closely related to those of orangutans and even some old world monkeys. If this were correct, it is likely that the smallest exclusive group that contains all humans would be the entire clade Catarrhini consisting of Old World Monkeys and the Apes (currently classified as approximately 100 extant species). This group would itself either be a species, or more likely, it may have some smaller exclusive groups within it so groups such as humans would be metasppecies (not part of any basal exclusive group). While this view does place species on firm ontological ground, it lacks much of the important theoretical and practical virtues of being able to recognize that there are genuine phylogenetic histories of far smaller groups (like humans). An additional problem is that like our earlier problem with species that were

simply too small, this account is simply too radical to be an account of *species*. Just how conservative a species concept has to be will depend on other virtues that it has and how it compares to other concepts. I would suggest that it is not obvious that *Homo sapiens* exactly delimits a species – for example, perhaps *Homo neanderthalensis* should be lumped together with it. However, a reasonable criterion would surely recognize that humans and chimpanzees are different species. If we did shift the meaning of species so that there could not be any discordant gene histories between species, then we would simply need to invent another taxonomic rank (perhaps subspecies) which would recognize groups such as humans and chimpanzees and would end up functioning in almost precisely the way that "species" functions now.

An obvious fix is to suggest that 100% exclusivity is not required to recognize that a group can form a taxa. Shaw (2001) drops this strict requirement and says, “Exclusivity, where members of the daughter population are more closely related to each other than to organisms outside the population, applies once the majority of gene copies each find their closest genealogical relative within that population” (Shaw 2001: 881) (emphasis added). Dawkins (2004) also suggests that in the future, we will think of phylogenies as recording what is true for a majority of genes.

Baum (2007) suggests that 50% is an arbitrary cutoff that has no real biological importance and instead suggests that the best concept of exclusivity makes use of what he calls “concordance factors” – the proportion of the genome for which a given clade is true. This view suggests that a divergent phylogeny arises over time and that there may be no precise moment at which reticulating network histories suddenly become divergent. The primary concordance tree is thus not the "full" Tree of Life which respects all aspects

of genealogy, rather, it is something like the best single tree that gets the most right (with respect to gene genealogies) if you have to pick just one. But the real history is simply a very complicated collection of gene trees. Many of these will overlap and that is what is represented on the primary concordance tree, but genes that have histories that differ from most other genes have real histories too that should not be dismissed or suppressed as some type of “error”. Rather, each gene has a real history. There is a difficult practical question of how to present as much relevant information as possible in a precise but compressed way, but there are no serious ontological difficulties with this picture of phylogenetic history as the history of genes.

We have now moved to a view where phylogenies will represent statistical distributions of gene genealogies just as Maddison had discussed. But rather than adopt the picture of taxa as nothing but "bags of genes", we have traveled through the very natural route of thinking of taxa (and therefore, species) as groups of organisms that form genealogical units. What has changed is simply how we measure how closely organisms are related to each other. The idea that the genealogy of an organism is tied to the genealogy of its genes is simply a consequence of understanding what kind of properties genealogies are supposed to have. Genealogies are supposed to represent the actual historical paths that allowed various bits of information from the past to causally influence the traits of organisms today where the causal relation was of a specific sort due to some sort of heritability conditions. While it is not obvious that our genes entirely capture all of the relevant heritable information, genes are obviously a large part of our genealogical history and ignoring them leaves us with a concept of phylogeny which by necessity misses something of great importance.

10. Criticisms of the genealogical species concept

While this gene-based view of a phylogenetic species concept has received relatively little attention in the literature, there have been some criticisms which I will examine here. Coyne and Orr (2004) do acknowledge that this “relaxed” version of the genealogical species concept (GSC) is the best phylogenetic concept (which in turn they seem to take to be the most serious alternative to the BSC) but they then argue that the BSC should be favored over the GSC.

They first criticize versions of the PSC which are defined in terms of monophyletic groups of organisms (they cite de Quieroz and Donoghue 1988, Rosen 1979, Mishler and Brandon 1987, and they mistakenly list Baum and Donoghue 1995 in this category as well). Their criticism has nothing to do with the difference between monophyly and exclusivity (which they mistakenly treat as coextensive) so we can treat it as a criticism of our species concept as well. They say “The main problem with this concept is operational: how can one *determine* whether a group is monophyletic and exclusive?”

The main problem as they see it stems from the fact that gene trees can have different histories. Gene trees are the evidence that we use to infer the history of taxa. If we define taxa as the history of organisms, then some gene trees will be misleading. If we sequence only one gene and assume that its genealogical history represents the history of taxa, then we could be mistaken about whether or not a group is in fact exclusive. But surely this is no problem at all. In all scientific endeavors it is possible to get misleading data. That is no reason to define your concepts operationally (Hull 1968). Rather, we

should treat our designation of a group as a species as a hypothesis – we believe that this group is exclusive and so meets a necessary condition for being a species. If it turns out that it is not exclusive, then it is not a species. There is no problem here. The typical way to overcome misleading data is by getting more data such that on balance, eventually we will have enough data to become convinced of the truth of the matter. But Coyne and Orr seem to think that this makes matters worse, since with more data, we become more and more certain that we will get at least some conflicting gene histories. But this is no reason to think that we cannot detect that a group is exclusive. The higher the percentage of genes that show concordant histories, the more probable it is that they come from an exclusive group (if exclusivity allows for concordance factors of less than 100%). When our sample of genes has a very high concordance factor, we can be nearly certain that if we sampled all of the genes they would have a high concordance factor, meaning that this group of organisms is exclusive. This is a straightforward inductive sampling problem and we do have to be aware of biased sampling, sample size, etc. but the merest hint of uncertainty is no reason to deny that we can reliably determine which groups are exclusive. Although we can achieve this high standard with enough data, it should be pointed out that we don't need to reach this standard in the first place. As before, this is an epistemological worry – even if we could not even reliably tell whether a group was exclusive or not, this would be no reason to doubt that exclusive groups are the real taxonomic groups. Epistemology does not dictate metaphysics.

Coyne and Orr believe that it is these epistemological worries that provided the necessary impetus for systematists to move to a gene-based understanding of exclusivity. As we saw earlier, they are incorrect about the motivation, since Baum and Shaw (1995)

clearly have metaphysical concerns about how to define exclusivity. But this is beside the point. Coyne and Orr now move to arguing that the BSC is superior to this gene-based version of the phylogenetic species concept which they call the GSC.

Coyne and Orr favor the BSC over this “relaxed” version of the GSC for three reasons. First, they say that the GSC results in many groups such as *Drosophila simulans* being placed in metasppecies and not in any species at all. This criticism is particularly ironic since the BSC is blamed for ignoring the vast majority of organisms by placing only sexually reproducing organisms in species. Their choice of example is also odd since they earlier claimed that the apparent paraphyly of *D. simulans* displayed by certain genes was almost certainly a case of gene trees differing from population trees. If so, *D. simulans* might very well be exclusive and in fact probably has exclusive groups nested inside it. But regardless, their main concern seems to be the way in which metasppecies are formed: “At the moment when an isolated population becomes monophyletic, every individual in every other population instantly loses its status as belonging to any species. It seems odd that, without any change in its own genetic composition, a group can lose species status based on what happens in a remote population” (Coyne and Orr 1994: 469).

Here, Coyne and Orr's criticism really turns out to be a criticism of a particular ranking criterion for species which we have not yet discussed. The suggestion of Baum and Shaw (1995) is that while all exclusive groups are taxa, it is basal taxa that are species. By basal they simply mean an exclusive group which has no exclusive groups inside it. I will discuss this ranking criterion and the status of metasppecies in the next chapter, but whether or not we accept this ranking criterion, I think that Coyne and Orr's

worries can be dismissed. In the first place, in this case, the larger group which was exclusive before the isolated group became exclusive still is exclusive and so still forms a taxon. What changes is that it is no longer basal since there is now an exclusive group nested inside it. The group that actually loses species status is this larger entity which the isolated population is a part of. So it is not surprising at all that it has changed. The group which "hasn't changed at all" wasn't exclusive before or after and so never had a status to lose.

Their second criticism is that nothing of biological importance happens at the completion of genealogical speciation. For example, nothing is different about a group where 49% of the genes are concordant versus a group with a 50% concordance factor. Again, it is odd for Coyne and Orr to raise this point since their version of the BSC does not require perfect reproductive isolation and it appears arbitrary just how strong the barriers to reproduction have to be for speciation to have occurred. Coyne and Orr clearly have in mind the "end product" – two new species that are fully isolated from each other – the obvious comparison would be two clades each with a concordance factor of 100%. Here, it is still true that in some sense, nothing of significance happens when reaching 100%. At least at the moment of full reproductive isolation (which will almost always occur long before reciprocal exclusivity) one could argue that the taxa will now be evolutionarily independent and will have lost the potential for merging (though there are certainly no guarantees here). The move to reciprocal exclusivity is merely evidence that this process of isolation has been going on for a long time. Coyne and Orr say that the reproductive barriers are thus more fundamental than genetic coalescence, which is merely an effect. But Shaw (2001) answers this by saying that there are many processes

which lead to the formation of clades and the divergence of groups. Intrinsic reproductive barriers are only one such factor. An exclusivity based view allows us to treat all possible processes as equally important and we simply measure the results rather than trying to focus on the one single causal process which is most important. The study of speciation for the BSC is the study of the evolution of intrinsic reproductive barriers. The study of speciation for the GSC is the study of divergence and clade formation in all of its forms – the study of intrinsic isolating mechanisms is thus a subset of the mechanisms of speciation which the GSC defender must take into account. What is interesting about speciation to the defender of the GSC is not the end product – two isolated groups which will forever remain isolated – but the process of divergence itself.

The third criticism that Coyne and Orr make does represent a real difference in the goals of the systematist who favors the GSC and one who favors the BSC. Coyne and Orr argue that genealogical speciation will often be transitory since allopatric populations may gain exclusivity without intrinsic isolation and this is no guarantee that they will stay exclusive when reproductive barriers are removed. As I mentioned previously, the evolution of intrinsic barriers to reproduction is no guarantee that there will always be such barriers, but Coyne and Orr are surely correct that external barriers such as geographical separation are much more fluid and apt to change over evolutionary time.

Before responding to this charge, I want to add that this last response of Coyne and Orr truly does represent a serious difference between the BSC and the GSC and this has been pointed out before. A particularly clear example that I would be remiss for not mentioning is Avise and Ball (1990).

The attitude of Coyne and Orr (2004) throughout is to determine not what concept of species is useful for biology, but what is useful for population genetics. An opposing goal represented by Nelson (1979), Donoghue (1985), and virtually all defenders of the PSC is to determine what species concept fits best in systematic theory. Baum and Shaw (1995) try to make some headway fitting the fields of population genetics and systematics into one coherent picture by linking the study of gene genealogies with species concepts, but they only succeed in sharpening a barrier between systematics and population genetics by drawing a sharp line between diverging and reticulating phylogenies. It is interesting that this idea of trying to connect systematics with population genetics was discussed earlier than Baum and Shaw (1995), but with very different results. Avise and Ball (1990) described the differences between organism pedigrees and gene genealogies and argued that population geneticists have ignored important systematic principles and have failed to take into account the power of history. But they also argue that systematists need to take seriously gene histories and population structure and realize that there is no simple divide between reticulation and divergence. While they conclude that the BSC is still the best way to delimit species, they acknowledge that the PSC does have many advantages that we should try to incorporate into systematics. They suggest that “population subdivisions concordantly identified by multiple independent genetic traits should constitute the population units worthy of recognition of phylogenetic taxa” (Avise and Ball 1990: 52). Of course, A and B can’t mean that these subdivisions should be equated with species since these authors defend the BSC. Instead they conclude that if these units are still reproductively compatible (such as might be the case if there were extrinsic reproductive barriers but not intrinsic

ones) then they should be formally named sub-species. Avise and Ball argue that many subspecies are simply recognized by very few or even one noticeable trait but that these groups are not necessarily true phylogenetic units and so multiple genes are needed, but they do not specify any particular cutoff. Presumably they would agree that if there were an overlapping group that had an even higher number of concordant gene genealogies then this group would have to be a taxon and so the first group could not be. If so, then this understanding of phylogenetic taxa might appear to be the same as the advocated by Baum (2007) with Baum simply using the term “species” to refer to the least inclusive phylogenetic units and so raising Avise and Ball’s “subspecies” to the rank of species. This is not entirely correct. Avise and Ball’s subspecies must be reproductively compatible since these authors retain (and privilege) the BSC as an understanding of species. Phylogenetic taxa as described by gene exclusivity can cut across species boundaries as defined by the BSC. That is, populations that are reproductively isolated from each other and parts of different biospecies can form groups that are genealogically exclusive. Baum would recognize such groups as taxa and simply ignore their compatibility with other populations whereas Avise and Ball cannot do this. While Baum (2007) delimits all clades on the basis of such concordance principles, Avise and Ball do not mention the delimitation of higher taxa, but they almost certainly believe they are constructed from species and thus cannot be delimited using concordance principles.

While Avise and Ball are certainly correct that systematics and population genetics need to learn from each other and that systematics taking into account gene genealogies is a step in the right direction, they fail to see the deep theoretical

inconsistency between phylogenetic taxa and the BSC. If we delimit species using the BSC, the non-exclusivity of some of these groups will inevitably bubble up to larger clades and we cannot have a consistent genealogy based taxonomic system.

Given what Avise and Ball say about the power of history and the importance of genealogically based inferences, it is clear that they would consider this a negative (as do Coyne and Orr though they also don't see the full extent of the problem). But Avise and Ball still defend the BSC based on what they see as the important difference between intrinsic and extrinsic reproductive barriers. This difference, which the BSC recognizes but all versions of the PSC ignore, is that extrinsic barriers are far more likely to be temporary and thus if we delimit taxa using the PSC, our *current* taxa might not *stay* taxa.

The BSC groups organisms by their potential for sharing descendants. But versions of the PSC group organisms by their shared ancestry. Which is better? Obviously, the best concept will depend on what we use the species concept for. It is clear that hybrid views such as that of Avise and Ball, who want to use the BSC because of the importance of biospecies for population genetics but then want to use the importance of monophyly at supraspecific levels, are unacceptable. Species cannot play both roles. If species are to be units of phylogeny, they must be genealogical units which are united by their past.

Taxa that are united by their unique, shared past need not stay that way. But there is no particular reason that they must stay that way in order to serve the purposes of systematics – recovering evolutionary history. It is certainly of biological interest to determine which of these groups are likely to stay exclusive, but attempting to build this into the definition of taxa necessarily disrupts our goals of recovering history.

11. Organisms or genes?

It is obvious that the study of gene genealogies is an important part of biology. Gene genealogies also provide an important source of evidence for organism pedigrees. Of course organisms do have real genealogies that we might have a practical reason to care about, but it might be thought that, biologically, all of the interesting genealogical action takes place at the level of genes. I do not think that this is quite right. While concordance factors are valuable tools in understanding exactly what phylogenies represent, organisms really do have a history of their own that is valuable for certain biological purposes. There are many processes and forces of evolution that act on whole organisms and not on genes directly. Careful study of such processes may require that we understand the specific patterns of mating between organisms independently of knowing anything about which genes are in which organisms. For example, monophyletic groups of organisms are valuable when tracing biogeographical patterns across time and space because geographic range is a heritable trait from parent to offspring. Here again, it is appropriate to think of lineages of organisms on their own terms rather than being defined by how closely related their genes are. And perhaps there is something important to be said for easy representation. On the phylogeny=gene-phylogeny picture, either phylogenetic trees simply do not represent parts of the Tree of Life or perhaps it is best to think that each gene has its own tree and so there are multiple Trees of Life. But the Tree of Life is naturally viewed as a single, unified diachronic object. Groups of organisms do form chunks on this Tree.

Genes have real genealogies that are biologically important to study.

Organisms have genealogical histories that are important to study. But there is no independent third level “the species level” that has a genealogy that is important to study. This is the “reductionist” part of the picture I am defending. We could let species simply represent exclusive groups of organisms and then it makes perfect sense to talk about the genealogy of a species. Exclusive groups of organisms could be defined either in terms of organism pedigrees or in terms of gene genealogies. Each is biologically important for certain types of explanations. But if we insist on a view of species that is not simply reducible to either of these “lower” levels, and then we insist that species have genealogies as defined by speciation events, we can construct a genealogy of species, but it does not function in biological explanations in the way that we want it to. Species would have ancestors and thus “genealogies”, but these genealogical histories would not track heritable traits over time, since these follow the gene histories and are constrained by the organism pedigrees. In cases where this "species" genealogy conflicts with these lower level histories, it is unclear why we should accept that the concept of genealogy applies at the species level at all.

FOUR

SPECIES AS A RANK

1. Species as a Rank

The conclusion that species must be monophyletic groups resolves many of the debates about species and constrains the ways in which species could be delimited, but it doesn't settle all of the questions about which groups are species. In particular, it leaves open the question of just which monophyletic groups of organisms are species. This is a *ranking* question. In this chapter, I will argue that the solution to this ranking question is in fact to deny that there is such a thing as the species rank. Therefore, in an important sense, there are no such things as species.

This is not deeply paradoxical – it is perfectly acceptable to argue that any species must satisfy certain necessary conditions and then to argue that in fact, nothing satisfies those conditions. However, the argument in this chapter is slightly different. I will proceed by arguing that a great many things satisfy the necessary conditions laid out in Chapters 2 and 3 but that they cannot all be species. Then I argue that there are no natural sufficient conditions for being a species. There may be reasons to keep the rank of species, but then it turns out that which exclusive groups are species is arbitrary and can perhaps be determined by convention, but that there are no natural divisions across all of life that uniquely pick out groups that we could delimit as species.

Recall from chapter 1 the distinction between grouping and ranking. There I argued that the tips of phylogenetic trees must be monophyletic groups. Thus “higher taxa” must be monophyletic since we need to be able to place them at the tips of trees. A ranking criterion tells us which monophyletic groups belong at which ranks in the hierarchy. Unlike grouping, ranking is an arbitrary matter. We could place taxa at whatever rank we wanted to and it would have no bearing on how we infer the Tree of Life or on any inferences that we might want to make using phylogenies. If we wanted to have categorical ranks that represented some objective distinctions in nature, we could rank groups based on the age of their origin, but attempting to analyze a whole host of information about a group (age, diversity, distinctiveness, complexity) and then combining all of the relevant information and converting it into a single rank leads to an arbitrary or subjective ranking criterion which is unhelpful and possibly even destructive.

When we argued that higher taxa must be monophyletic, it turned out that that exact argument carried over to show that all taxa, including species, must be monophyletic. A natural position to hold is that since the grouping criterion should be the same for species and for higher taxa, the ranking criterion should be the same as well. In other words, the rank of species should be arbitrary in the same way that it is for higher taxa. This would be consistent with the theoretical position that while there is something special about *taxa*, there is nothing fundamentally special about *species* as opposed to other taxa. This is the position that I will defend here.

It is unclear exactly what Darwin thought about the nature of species since some of his writings appear inconsistent on this point (see Mayr 1959, 1982:264), but at least in the *Origin*, Darwin treats species in the same way as other taxa. “From these remarks it

will be seen that I look at the term species, as one arbitrarily given for the sake of convenience to a set of individuals closely resembling each other, and that it does not essentially differ from the term variety, which is given to less distinct and more fluctuating forms (Darwin 1859: 52). And later, “In short, we shall have to treat species in the same manner as those naturalists treat genera, who admit that genera are merely artificial combinations made for convenience. This may not be a cheering prospect; but we shall at least be freed from the vain search for the undiscovered and undiscoverable essence of the term species” (Darwin 1859: 485).

What Darwin says here is a bit odd, since as pointed out in chapter 1, Darwin believed in genealogical classification, which would mean that genera (and species) are not simply artificial combinations made for convenience. Perhaps he was simply talking about the groups that systematists of his time *thought* were species. But regardless of this inconsistency, the point remains that Darwin did not see any fundamental difference between species and higher taxa.

In Chapter 2, I described and argued against the common view that the importance of monophyly in grouping organisms into taxa does not apply to species. With ranking, there is a similarly common view that the arbitrary nature of the higher ranks does not extend to the species level. On this view, we might lack a reason to assign a particular group to the rank of genus, but that we can correctly assign certain groups to the rank of species. This position – that there is some fundamental distinction between species and other taxa – is the dominant position in biology. Mayr (1942[1999]) chastises Darwin on just this point claiming that his view of species in *The Origin of Species* is mistitled as in fact he has no view on the origin of species, but rather, only

about the origin and maintenance of diversity. Furthermore, rejecting the reality of the species rank might seem to imply that either there is no such thing as speciation, or if there is, it is not a fundamental or especially important biological phenomenon. In fact, the very term “speciation” already seems to imply that there is something special about species. And other linguistic distinctions seem to draw a line between “species” and “higher taxa”. For example, while not widely used, Mayr commonly distinguished Microtaxonomy as the classification of organisms into species while Macrotaxonomy is the classification of species into higher taxa (e.g. Mayr 1969 and Ashlock 1969, 1991). On the other hand, a distinction that is often made is that Microevolution is change that takes place within a species, whereas the study of Macroevolution studies changes above the species level. The widespread use of these terms implies that many biologists believe that there is something fundamentally different about species.

The position that there is a fundamental difference between species and higher taxa is the dominant view even among phylogenetic systematists. For example, in PhyloCode, an emerging system of phylogenetic nomenclature, there are two types of taxa, clades and species, with different nomenclatural rules for each. The system is called a rank-free classification system of nomenclature, but technically speaking, that is incorrect as there is one rank – species. Kevin de Quieroz, a leading phylogenetic systematist and one of the principal driving forces behind PhyloCode has repeatedly argued that species are special types of taxa since they are lineages, not clades, and they are evolutionary units and not merely the products of evolutionary processes like higher taxa (de Quieroz 1998, 1999, 2005a, 2005b, 2005c).

Defenders of PhyloCode are certainly not alone in thinking that there is something fundamentally different about species as groups of organisms, or different about species as a rank, or both. Leading systematists in the cladistic school make similar arguments. Wiley (1981), Nelson and Platnick (1981), and Nixon and Wheeler (1990), all agree that species are evolutionary units and that higher taxa are not. And noncladists such as Mayr (1970: 373-4), Eldredge and Cracraft (1980: 89-90, 249), and Ghiselin (1987: 141) all defend the position that species are fundamentally different kinds of things than higher taxa since species are individuals and are real groups whereas higher taxa are classes and are not real (or at least, they are not real in the same sense as species).

Many reasons for thinking that species are special derive from views that would preclude species as clades. For example, Eldredge and Cracraft (1980: 89-90, 249) argue that species are the units of evolution which, according to them, implies that they must have ancestor-descendant relationships whereas higher taxa must be monophyletic and so cannot have descendants.

Given the variety of reasons given for thinking that species are different than higher taxa, it is not unreasonable to try to find a non-arbitrary ranking criterion for species, even while allowing that the grouping criterion for species is just the same as for other taxa. The natural first place to look for such a ranking criterion is with defenders of a Phylogenetic Species Concept who are careful to make the distinction between grouping and ranking in the first place.

2. Species as basal taxa

Recall that Mishler and Theriot (taking their cue from Mishler and Brandon 1987) say, “Taxa are ranked as species rather than at some higher level because they are the smallest monophyletic groups deemed worthy of formal recognition, because of the amount of support for their monophyly and/or because of their importance in biological processes operating on the lineage in question” (Mishler and Theriot 2000: 46,47).

In other words, there is a nested hierarchy of monophyletic groups within groups, but some are so small that they should not be part of our formal classification system. Perhaps they are made up of only a few organisms. But some groups are important enough to be called taxa. Among these, the least inclusive are the species since that is the least inclusive rank. Here we are offered a reason for thinking that there is something special about species – they are taxa that have no taxa inside them.

Once we correct the mistake of building epistemology into the definition as mentioned in Chapter 3, their view still leaves open a number of options regarding the objectivity of ranking. For example, Mishler and Donoghue (1982) have argued for pluralism with respect to species – but they do not have in mind the pluralism of LaPorte (2005), Dupré (1993, 1999, 2001) and a host of others who argue that non-monophyletic groups can be species; rather, Mishler and Donoghue defend a pluralism about the kinds of processes that make it appropriate to rank certain groups as species. For example, reproductive isolation, ecological pressures, and morphological criteria cannot be used as part of the grouping criterion, but they are all appropriate to take into consideration for ranking. While they give ranking criteria, it is not clear whether they think there can be an objectively correct answer to which groups ought to be ranked as species or whether

they are pluralistic about that as well. Mishler and Brandon (1987) are much clearer on this point. They agree with Mishler and Donoghue (1982) that species must be monophyletic and they agree that pluralism about evolutionary processes is required, but they make clear that they think that there is an objectively correct answer to the ranking question in any particular case. They explicitly say that in each biological case, there is an objectively correct answer to the question of which groups are species. Their pluralism stems from the fact that the reason why a group is ranked as a species can be different from case to case.

This view about species ranking ought to remind the reader of a particular view about an objective assignment of ranks at the higher levels as discussed in Chapter 1. One view holds that there is an objectively correct answer as to why this group is a family rather than a genus – but it just may not be the same answer for why a different group is also a family. But, as was argued in Chapter 1, a better theoretical system simply says that there are no such things as ranks since, in any particular case, there is no reason that that group has to be a family rather than a genus.

Mishler and his coauthors may prefer to hold the view that ranking is arbitrary at the higher categories – but that there is something special about the species rank. They look to the fact that in one sense, of course, there is something special about the species rank – species is the least inclusive rank. So if we do have a hierarchical list of taxa and then we try to rank them, we can at least rank the species by simply assigning that rank to the least inclusive groups. While a common view, this turns out to be deeply problematic.

It is worth pointing out that this view that what makes species special is just that they are the smallest taxa denies that there are ranks like subspecies which are commonly used, but many authors have been content to give up subspecies – or at least to say that in the relevant sense, subspecies are not really taxa. This is especially prevalent among phylogenetic systematists for just this reason. Getting rid of subspecies, varieties, and other subspecific categories does have the effect of making species smaller than often traditionally thought. For example, Cracraft (1997) and Martin (1996) estimate that the number of species of birds would be raised from approximately 10,000 to approximately 20,000 by raising the rank of well-defined subspecies of birds to the rank of species. While it isn't clear that this would be a problem, the situation is far worse than this. It might be acceptable to have species be slightly less inclusive than we may have previously thought, but in fact, the smallest taxa are far smaller than this.

Baum and Shaw (1995) take as one of their starting points that species just are the basal (or least inclusive) taxa. But they also assume that all clades are taxa. From a phylogenetic perspective, this makes perfect sense. But as Baum and Shaw point out, if we define a clade as any ancestor and all of its descendants, this would mean that each birth then gives rise to a new clade and so the smallest clades are truly small indeed, consisting of just two organisms. This obviously won't work for species, which is why Baum and Shaw prefer to characterize clades in a non-standard way.

Incidentally, versions of the diagnostic approach to the Phylogenetic Species Concept suffer a related problem. For example, Cracraft (1983) defines a species as “the smallest diagnosable cluster of individual organisms within which there is a parental pattern of ancestry and descent” (Cracraft, 1983:170). But individual organisms have

unique combinations of traits, so depending on what exactly is meant by “diagnosable”, the size of a species could be reduced to individual organisms or perhaps a small family in order to satisfy the “parental pattern” part of the definition. Because of this criticism, newer definitions (of what is explicitly claimed to be the same concept) such as those of Wheeler and Platnick as noted above, define a species as “the smallest aggregation of (sexual) populations or (asexual) lineages diagnosable by a unique combination of character states” (Wheeler and Platnick 2000: 58). Here, in sexual groups, the species could not be reduced to below the size of a single population, but in the case of asexuals, if a lineage could be constituted by only a few organisms, then a version of the problem remains. Species would be far too small to be reasonable as taxonomic units.

The problem in each case is the same. From the standpoint of phylogenetics, there is no particular reason to think that very small groups, including groups of only a few organisms, cannot be taxa. These small groups have genealogical histories just like the larger groups as discussed in Baum (2007). We could choose simply to define species as the smallest taxa, but then species would be so far from the traditional usage of the term that species would cease to have most of the properties traditionally given to them and it is unclear why species would be an interesting biological category. Although we should be open to changing some traditional aspects of species, changing the concept to one in which the typical species is only a few organisms and persists for only a generation is clearly unacceptable. Inclusiveness cannot be what makes species special.

Since we can't hold both that species are the smallest taxa and that all monophyletic groups form taxa, Mishler and Brandon imply that only certain groups are important enough to be worth denoting as taxa. However, this merely shifts the problem,

as determining the importance of a group is going to be subjectively based on our interests which will certainly vary across subfields in biology and even across individual practitioners. The position that only some monophyletic groups are taxa is particularly problematic for phylogenetic systematists who stress the importance of discovering clades at all levels. This idea that all clades are equal is a major reason to ignore the higher ranks when attempting to find deep phylogenetic connections between the various “phyla” of animals or “divisions” in plants. Similarly, there is nothing wrong with trying to determine “intraspecies” phylogenies that are important for discovering the history of various populations or genes or traits within a single species. And of course if we are considering taxa just to be groups of organisms that have unique genealogies and thus can be placed on phylogenetic trees, size is of no importance. If we want to have a reason to rank certain groups as species, it seems best to search for a ranking criterion that picks certain monophyletic groups out as special rather than searching for a criterion for why certain monophyletic groups should be taxa.

3. Species as individuals

One reason that has been given for thinking that species are special kinds of taxa is that species are individuals rather than mere classes like other taxa. That species are individuals can reasonably be called the dominant view in philosophy of biology today, though it has been defended only relatively recently in the history of theorizing about the diversity of life. The historical tradition going back at least to Aristotle is to treat species as natural kinds. That is, there are natural divisions in nature and when we attempt to divide up the living world, the species to which an organism belongs represents the *kind*

of thing that it is. This view was coupled with an Essentialist picture – that being a member of a certain species was a matter of having certain properties which were essential to being of that species. Not only was it the case that these essential properties were such that all and only members of the species had them, but they also were central to explaining other properties of organisms in the species. (Sober, 1980)

Then, beginning in the 1960's and 70's, Michael Ghiselin and David Hull waged a campaign to convince biologists and philosophers that species were in fact individuals. (Ghiselin 1966, 1969, 1974, 1987, 1997 and Hull 1974, 1975, 1976, 1978, 1980).

Ghiselin explicitly argued that in a logical sense they were individuals rather than classes where the natural kind thesis is implicitly assumed to be a class-based view of species.

The species-as-individuals (SAI) view is now fairly well entrenched although there certainly have been critics such as Philip Kitcher (1984, 1987) who argued that species should be thought of as sets. Interestingly, while Kitcher himself denies that species are individuals, he does believe that this position is logically consistent with the SAI thesis.

Some authors argue that the natural kinds view of species is actually neutral on the SAI thesis as well. Recently, the natural kinds view has undergone a resurgence (for example, Boyd 1999, Wilson 1999, 2005, 2007, Griffiths 1999, Reippel 2007 and see Wilson et. al forthcoming for a host of others) and some of its defenders accept the SAI thesis while others explicitly reject it. It may well be that the idea that species are natural kinds also does not answer the question of whether species are classes or sets or individuals. There are many senses of the word individual and depending on exactly what is meant, individuality may be compatible with a variety of different views of what species are.

There is no shortage of ways to understand species as individuals in the literature. Possibilities include, but are not limited to, “physical individuals” (Gayon 1996, Stamos 1998); “substantial beings” (Borjesson 1999); “individuals with respect to evolutionary theory” (Williams 1985); “concrete particular persisting individuals” (Crane 2004); “physical objects” (Holsinger 1984); “causally integrated individuals” (Ereshefsky 2001 and see Mayr 1987, Sober 1993); “biological individuals” (de Quieroz 1999); or “spatiotemporally localized cohesive and continuous individuals” (Hull 1978). For each of these broad types, different definitions might be given.

I will not attempt to settle the question of whether or not species are individuals; rather, I merely want to clarify some important aspects of the debate and to develop crucial distinctions so that we can proceed with understanding what role species play in phylogenetics. Thinking carefully about whether species are individuals naturally leads to careful thinking about species ontology generally. My primary concern here is to argue that individuality cannot be the relevant criterion that marks an important distinction between species and higher taxa. By reinforcing the idea that species are like other taxa, this argument also provides additional reasons to think that species must be clades and that non-phylogenetic species concepts such as the BSC are inappropriate for systematics.

Once we emphasize that we are specifically looking for a difference between species and higher taxa, several possible ways of understanding individuality can easily be seen to be irrelevant. For example, Baum (1998) argues that an individual is just a collection of parts more closely related to each other than to any parts outside the group. By “related” here, Baum is thinking of genealogical relatedness. On this understanding,

exclusive groups of organisms form individuals. But if all taxa are exclusive groups (as Baum advocates) then they are simply all individuals. Here there is no difference between species and higher taxa.

Ghiselin (1987: 363) and Rosenberg (1985: 204) emphasize the spatio-temporal restriction of individuals as opposed to the abstract nature of classes, which implies that they could conceivably contain members anywhere in the universe). Hull (1980) goes even further by claiming that they are spatio-temporally continuous entities. If species were defined by pure similarity, then there could possibly be tigers on other planets that have no genealogical connection to earth tigers, but just happen to be striped, clawed, have sharp teeth, and could even be indistinguishable from earth tigers in every way. But Ghiselin and Hull want species to be tied to the evolutionary process and to be historical individuals and so argue that such creatures would not actually be tigers because they are not part of the same historical entity. Hence they have a conjunctive criterion: being historically connected (which they think allows for paraphyletic species) **and** some other criterion of individuality – usually interbreeding potential.

On a side note, this does lead to an internal inconsistency in defenders of the BSC who hold this type of individuality since it is certainly possible that these Martian tigers can potentially interbreed with Earth tigers. So according to the BSC, they should be part of the same species. The general point is just that since the BSC allows polyphyletic groups to be species, there is no guarantee that a species is actually a historical individual. Only an explicitly genealogical view of species can guarantee that species are historical entities in the right way.

At any rate, spatio-temporal location and continuity is obviously not going to separate species from the higher taxa for just as sure as *Panthera tigris* has a spatio-temporal location, *Panthera*, Felidae, and all the other taxa that tigers are part of have spatio-temporal continuity as well. The same observation will apply to a point that Hull makes about there not being laws about particular species since species are individuals rather than natural kinds (Hull 1978). Even if this were correct, the same reasons given for why species cannot be subject to general laws (species evolve and can change their properties over time) will also apply to higher taxa.

But while some understandings of individuality make it clear that all taxa are individuals, many do not, so it is worth delving more deeply into this debate in order to see if we can find some property or properties that make species special.

4. Category vs. taxon

Once we enter into the realm of discussing the ontological nature of species, it is essential to point out a crucial distinction that is often described as the distinction between the species category and a species taxon. Ernst Mayr has made a habit of criticizing most of his opponents in just about all of his writings on the subject of species by claiming that they are paying insufficient attention to this fundamental difference. He seems particularly keen on mentioning the frequency of this mistake and he freely admits that he was confused about the issue for a while himself (Mayr 1976). For an early example, in a half-page article titled “Is the Species a Class or an Individual?” (Mayr 1976), Mayr claims that the two sides in the debate are simply talking past each other and are both correct – the species taxon is an individual with organisms as its parts while the species

category is a class, the members of which are the species taxa. After pointing this out he says that “I am rather confident that due attention to this distinction will terminate the argument stated in the heading of this note.” Twenty-four years later, Mayr was still claiming that understanding this distinction was the key to understanding the species problem. As he says in his 2000 position piece “The word *taxon* refers to a concrete zoological or botanical object consisting of a classifiable population (or group of populations) of organisms. The house sparrow (*Passer domesticus*) and the potato (*Solanum tuberosum*) are species taxa. Species taxa are particulars, individuals, or biopopulations.” On the other hand, in the species category, “the word *species* indicates a rank in the Linnaean hierarchy. The species category is the class that contains all taxa of species rank.” (Mayr 2000: 22,23)

Certainly, Mayr is partially correct. It is important to distinguish “species” – the rank - from actual groups that we may claim are species – like *Homo sapiens*. But he is certainly wrong that this is the key to solving the debate about individuality. It would be completely unreasonable to claim that the species category is in fact an individual. That would be an obvious category mistake, and one that has rarely been made. The debate is about whether an actual species, like *Homo sapiens* is an individual or whether it is a class, or a set, or something else entirely. Those who believe that species are sets believe that they are sets of *organisms*. It is species taxa that are groups of organisms, not the species rank, so it is clear that Kitcher and others who deny that species are individuals are indeed talking about species taxa.

Although paying attention to the distinction between the species category and species taxa doesn't immediately answer the question of whether species are individuals,

it does allow us to sidestep many of the deep metaphysical debates that are thought to be relevant to the status of species. For example, it is often thought that certain metaphysical debates such as the problem of universals and the questions of realism vs. nominalism have obvious implications for the species debate (Mayr 1982: 264, Mayr and Ashlock 1991: 24, Hey 2001). One basic argument I will consider is the following: nominalism implies that individuals are real whereas classes are not real. Since species are real, species must be individuals.

5. Sidestepping more metaphysics

One reason that the SAI thesis might be important is if individuality were tied to existence. For example, Ghiselin 1997 argues against the species-as-classes idea by emphasizing that species are *real*. Of course the implication is that they would not be real if they were classes.

Ghiselin's discussion starts from the basic idea that individuals are concrete while classes are abstract. Nominalism generally is simply the view that abstract objects do not exist. Thus the nominalistic species concept, which treats species as classes, says that since they are classes, they are abstract and so strictly speaking, do not exist. Burma (1954) and Gregg (1950) accept both the idea that species are classes and that therefore species don't exist. Jody Hey (2001) describes the relevant positions in the debate and then argues that categories (such as species) are real because they exist in the mind. We must use the tools of psychology in order to study such categories. Often these categories can pick out real divisions in nature, but sometimes they don't.

But questions about realism vs. nominalism and related metaphysical problems such as the problem of universals are entirely beside the point. Mayr argues that species are real because there are real discontinuities in nature and that there is structure to the diversity of life. Coyne and Orr (2004: 10) argue that species are real for the same reason and incidentally, argue against Darwin's understanding of species in the *Origin* because they take his stance there (as evidenced from the above quotes) to be that species are not real. Their argument for the reality of species hinges on the idea that one conceivable way in which the diversity of life could be distributed is that the phenotypes of organisms could be arranged in one great continuum. In this scenario, we could draw boundaries, but they would be merely arbitrary boundaries. But the world is not like this. At any particular moment in time, there are genuine discontinuities and these real groups are species. In fact, Coyne and Orr argue that many groups in nature do not form such discrete clusters (such as many uniparental groups) and this is precisely why they believe that there are no species in these groups. Their use of the BSC supports this conclusion. Mayr uses these facts about biological reality to argue against what he calls the nominalistic species concept and seems to take his argument as an argument against the metaphysical position of nominalism itself! (Mayr 1982: 264, Mayr and Ashlock 1991: 24-25).

But the distribution of phenotypes on earth certainly does not count as a solution to the problem of universals nor does the reality of species count against species-as-classes in combination with various metaphysical positions. It is important to note that even if we accepted the most extreme form of nominalism, we could still accept nearly everything that Mayr says. Certainly the nominalist accepts facts about the distribution

of the diversity of life. The nominalist accepts the existence of individual organisms and of course that there are facts about what traits they have and this will completely fix facts about whether they form discontinuities or not. We might choose to name a particular group of organisms such as *Homo sapiens*. The nominalist can accept that the borders around this group represent a real discontinuity in nature. What the nominalistic denies is that there is a further existing thing *Homo sapiens* that exists above and beyond the existence of each of the particular humans. *Homo sapiens* is a category and our categories are such that instances of them (like individual humans) certainly exist but the category itself does not.

Of course we may want to understand the realism debate in some different way and Mayr may simply be misunderstanding nominalism. But there is a deeper point to be made here which reinforces the idea that for our purposes, we are looking in the wrong place. We are looking for something that makes species special. Perhaps species are real. But that does not make them *more* real than higher taxa. For example, *Homo sapiens* does represent a real discontinuity in nature on several different scales (genealogical, phenotypic, genetic) but there is a structure to the discontinuities – namely, they are arranged in a nested hierarchical pattern. *Homo sapiens*, *Homo*, Hominini, Homininae, Hominidae, and all the other taxa that humans are a part of, *all* represent real discontinuities in nature. If that is what it takes to be real, then surely these higher taxa are real as well. This is not something that could mark species as special. Each side in the realism vs. nominalism debate will agree that species as a category and species as taxa are equally real. The realist will argue that each individual taxon is real and in addition, the categories that the taxa fall under, such as “species” are also real. On the

other hand, the nominalist will agree that the individual taxa do exist (*Homo sapiens* is a real, non-arbitrary group of organisms and Mammalia is also a real group of organisms) but disagree with the realist and claim that this does not mean that the abstract class *Homo sapiens* or the abstract class Mammalia exists. In all four combinations, whether we are realist or nominalist, or accept the view that species are individuals or accept the view that species are classes, species are not fundamentally different from other taxa.

Although it certainly seems clear that higher taxa are real and that this implies no difference between species and higher taxa in this way, many authors have thought otherwise. For example, Mayr (1963: 600-601, 1969: 91-92) and Simpson (1961:188-191) argue that higher taxa are subjective and arbitrary whereas species are real and natural. This would be a difference, but Mayr and Simpson think that higher taxa are subjective and arbitrary because they are supporters of Evolutionary Classification where higher taxa *really are* delimited in an arbitrary way. For Mayr and Simpson, species are prior to us – they exist in nature. In contrast, the higher taxa are man-made. Classification is something done by humans for humans. It is our classification schemes which delimit higher taxa. Unlike species, higher taxa do not exist independently of us but are created by us. This is completely wrongheaded from the standpoint of phylogenetic systematics where phylogenetics is an attempt to discover what the real taxa are. If we restrict the higher taxa to clades, they are clearly not subjective and arbitrary but rather, are natural divisions in the diversity of life. Our question here is whether *among the nested hierarchy of clades* there are some special properties of some clades such that we could objectively rank them at the level of the species.

But even moving to monophyletic higher taxa does not eliminate the problem for every author. Coyne and Orr (2004) claim that “Most biologists agree that species are real in a way that supraspecific taxa are not.” However, their discussion is confused in several respects. First, they say that “because evolutionary trees can branch at any level, higher level groupings are necessarily arbitrary” (Coyne and Orr 2004: 16). However, it is clear from context that they are claiming only this: even if we grouped higher taxa using monophyly, that ranking would be arbitrary. From this conclusion about arbitrary ranking, they seem to conclude that the higher taxa, such as the genus *Drosophila* would not be real, but as I argued earlier, this does not follow. We are not asking if the higher ranks, like genus and family, exist rather, we are asking if the higher taxa, like *Drosophila* and *Drosophilidae* exist.

Coyne and Orr give a second argument after they describe the empirical facts about clades in a particular group of *Drosophila*; they say (of the clades), “but there are many such groups, which overlap in a nested fashion. The ‘reality’ of such groups thus consists only in their common ancestry and the traits that allow us to recognize it. Unlike species, such groups do not evolve as a unit nor are they homogenized by interbreeding” (Coyne and Orr 2004: 17). The quotation marks around “reality” imply that they are not willing to accept that clades are real simply because they are clades. But of course they should – discontinuities in phenotypic space were enough for them to declare species real before and such discontinuities exist at higher levels as well. But their main point here seems to be not that clades are unreal, but that they are simply different than species because species have special properties that larger clades lack – they evolve as a unit and are homogenized by interbreeding. We will deal with this possible difference between

species and higher taxa momentarily, but clearly these properties are not necessary for being a real, non-arbitrary group so this argument also fails to show what it purports to show.

The third argument given by Coyne and Orr to show that higher taxa are not real is that there is a breakdown of the correspondence between folk and Linnaean taxonomy above the species level. To be fair, it is not obvious that Coyne and Orr mean this to be a serious argument; they may just be pointing out an interesting fact. On the other hand, the context indicates that they do think that this has something to do with the nonreality of higher taxa and they had previously used the correspondence between folk taxonomy and professional systematic opinion at the level of species as a reason to think that species are real. So it can't be entirely unfair. At any rate, they point out that folk classifications, such as the one of the Tzeltal (described in Berlin 1992) often create higher taxa such as the following: "trees", "vines", "grasses", and "broad-leafed herbs" which represent polyphyletic groups. We could add to this that other folk taxonomic classifications will certainly divide up the world in different ways and of course the phylogenetic system of classification described in chapter 1 does not allow such taxa. But this is no reason to think that these groups do not exist and it is certainly no reason to think that taxa as described by professional taxonomists do not exist. The fact that the Tzeltal do not recognize that the angiosperms form a real group has no bearing whatever on the fact that they are a clade, and in general, epistemological facts about disagreement among humans bear little relationship to the relevant metaphysical facts. This is particularly clear in this case since there is no reason to think that the Tzeltal have all of the relevant information, such as genealogical, genetic, morphological and ecological

facts, about various groups of plants. Disagreement among experts who share all of the relevant information might give us some pause, but surely disagreement among non-experts is no surprise at all, much less an argument against the metaphysical reality of various groups.

6. An ambiguous debate

The thought that species are real while higher taxa are not real fails to yield a distinction that separates species from higher taxa. We began this discussion of the reality of taxa because it has been argued that we need species to be individuals if they are to be real. While this does not appear to be the case, we have not made much progress in understanding whether species are individuals. As noted above, there are a number of different ways of understanding individuality. At least two very different metaphysical debates have been taken to crystallize the key distinction that individuality is supposed to represent. One such debate is whether or not species are delimited (as groups) in a non-arbitrary way. Here, the relevant distinction is something like real vs. artificial. Some authors have thought that species differ from higher taxa in this regard, but phylogenetic systematics ensures that all taxa are clades and so are delimited in objective, mind-independent ways. Another such metaphysical debate, which is often central to discussions of whether species are individuals, concerns whether or not species are integrated in the right sort of way such that they have emergent properties of their own. This leaves us with two ways to think of the individuality thesis. We can hold on to a notion of individuality such as the one that Ghiselin wants to defend (basically, meaning “not abstract”) and we could still be searching for a reason that species are different than

higher taxa. Here the point is not that species are individuals while higher taxa are not, since they are both individuals; rather, what makes species different is that they are a special *type* of individual. A second way of framing the debate, which is probably the more popular route, is to treat individuality not as a very weak logical notion, but as a robust property that some objects have and others don't. Perhaps we are even searching for a special kind of "biological individual". This more robust notion of individual is the notion that I will work with for the remainder of the chapter.

If species are individuals, the natural view is that they have organisms as their parts (though this could be denied – for example, species could be composed of populations.) Of course the organisms that make up a species will bear many relations to each other such as "are located within x meters of each other", but we want to know if they possess the right type of relationships for the group as a whole to possess cohesion, coherence, integration, or whatever is needed for the species as a whole to have a special type of unity. Causal connectedness seems like a natural place to start (Sober 1980) but that is open to many interpretations. For example, Baum (1998) argues that clades are causally connected because they are connected by common causes via evolution by common descent. But many authors argue that more is needed. Hull, for example, writes "[I]ntegration by descent is only a necessary condition for individuality, it is not sufficient. If it were, all genes, all organisms and all species would form but a single individual. A certain cohesiveness is also required . . ." (Hull 1976: 183, see also 1980: 313). As pointed out above, saying that "cohesiveness" is needed obviously leaves open a number of interpretations (Wilson and Barker forthcoming).

Here, an analogy with organisms has been particularly powerful. Organisms are the paradigm of biological individuals, so if we understand why they are individuals, perhaps we can compare them to species. Organisms have smaller parts inside them. For example, individual cells are parts of organisms as are atoms, DNA molecules, nuclear genomes and many other entities. An organism is not a mere aggregation of cells such that a cell is a *member* of an organism – rather, a cell is a proper *part* of the organism. The organism as a whole has a unity whose cells are parts that are integrated together to form a larger entity. Hull (1978) argues that species should be thought of in the same way. Just as cells are part of organisms, organisms themselves are parts of a larger entity – species. This may be jumping an ontological step. It may well be that organisms are parts of populations (also biological individuals) which are themselves parts of species. Of course if parthood is a transitive relation as is often assumed, then organisms are still parts of species anyway. But the key here is that either way, organisms are not *members* of species as they would be if species were sets.

What makes organisms entities that have just the right type of coherence necessary for biological individuality? An obvious thought is that there are causal properties that unite their various parts together into a unified synchronic entity. Cells in Bob's left hand and right leg are both part of the same organism because of a series of causal/functional connections between them. On the other hand, the cells of Jane's right leg are not part of the same organism as those in Bob's left hand because the group formed from combining them lacks the right kind of cohesion and integration.

A second property that might be thought to go well with synchronic cohesion (or at least not contradict it) is that organisms also have genealogies. They have parents and

they have various properties because of their descent from these parents. In other words, synchronic causal interactions unite organisms as individuals and diachronic causal connections relate organisms to each other genealogically. These seem to be independent properties and they don't seem to be in conflict. But as pointed out in Chapter 3, there does seem to be an obvious problem with organisms having both of these features when we consider gut flora and new problems arise when we consider parts such as transplanted hearts. Synchronically, by any cohesion standard they are part of the whole organism but they are clearly not the relevant parts when we say that the organism has a clear identity through time and has two biological parents.

Regardless of the tension between the synchronic and diachronic understandings of organisms, it seems clear that organisms are individual entities in their own right with their own properties and they are participants in various processes and not mere collections of cells. Both synchronic and diachronic properties contribute to this. Organisms are born, they persist, and they die. They can travel as a single unit, compete with other organisms for resources, and they can change over time by gaining and losing parts that differ in properties. Their parts share a common fate. These all seem to be reasons to take organisms seriously as independent biological entities in their own right apart from the genes, cells, and organs that make them up.

To take seriously the species as individuals view, it seems we need also to take seriously this analogy between species and organisms. Just as cells are parts of organisms, organisms are parts of species. If the organisms are interacting in the right way and have a special type of cohesion, they can be part of a larger individual – a species. Species are also thought to have genealogies. As with organisms, species have

parents (a single parent, typically) and offspring. Species are born (during a speciation), persist through time, and die (at extinction). They have locations that can change (a species might invade an island), they compete with other species for resources, and they change over time by evolving. To evolve, they replace old parts (organisms die) with new parts that have slightly different properties.

As in the case of organisms, the idea that species have synchronic and diachronic properties that correspond to various properties of organisms in a tight way has not been thought to be problematic. In fact, some biologists have thought they even reinforce each other and mutually support and are supported by certain species concepts such as the BSC. It is something of a surprise that this is exactly wrong. The species as individuals view very naturally looks to something like the BSC or the ESC for support. With the BSC, gene flow is supposed literally to be the force that holds the species together (but see Barker forthcoming). With the ESC, selective forces acting on organisms in the same ecological niche cause a type of cohesion among the organisms in a species. The Cohesion Species Concept (Templeton 1989) allows a multiplicity of cohesion mechanisms. However, as pointed out by Barker (unpublished, forthcoming), the parts of organisms are delineated by material connectedness whereas this would naturally lead to species being denied individuality.

Even if we allow that organisms can be synchronically connected by the right kinds of cohesion forces on the BSC, ESC, or Cohesion Species Concept, if species are to have genealogies, we must abandon these species concepts. Only a phylogenetic species concept, one that demands historical cohesion of the parts of species, makes sense of the idea that species are truly genealogically related to other species. If we force

interbreeding groups or ecological groups (or any synchronically cohesive group) into a genealogical framework, the ancestor/descendant relationships between species will conflict with the ancestor/descendent relationships of the organisms that make up the species. Assigning these groups a single parent species (as determined by some speciation criterion) is misleading with regard to what genealogy really means. If we want species to be genealogical units, they can't be interbreeding or ecological units.

Just because many of the defenders of the SAI thesis often rely on the BSC to support their conclusion does not mean that abandoning the BSC should lead us to abandon the SAI thesis. There may be different reasons that we should think of species as individuals. Another common reason given for thinking that species are individuals is that species play a certain role in evolutionary theory that requires them to be individuals. Again, this is often coupled with the BSC, but it can easily be divorced from that idea. Some authors explicitly link the SAI thesis to the species as evolutionary units idea (Mayr, Ghiselin, Hull, Williams 1985) but many authors who focus on the idea that species are evolutionary units but do not mention individuality would no doubt be amenable to the SAI thesis (Gould 2002, Wiley 1981). It is not obvious that the SAI thesis is tied to the idea that species are evolutionary units. But regardless of its connection to individuality, if species are evolutionary units (and higher taxa aren't), this could possibly provide us with the ranking criterion that we are searching for.

7. Species as evolutionary units

What if we take seriously the view that species are special because they are evolutionary units? This is certainly a popular view – for example, an early anthology of important

papers on species has been called *The Units of Evolution: Essays on the Nature of Species* (Ereshefsky 1992). Of course it is perfectly reasonable to attempt to figure out whether evolutionary units are objective features of the world and what they are like. What is questionable is that these evolutionary units should be equated with species. Mayr, Hull, Ghiselin, and others seem to want to have it both ways. Species are individuals and players in the evolutionary process, but species are also the units of taxonomy and classification. In fact, they are the units of phylogeny as well since clades are clades of species. But this simply will not do. As I will argue, our best views of evolutionary units and our best views of taxonomy imply that these groups are not the same and the term “species” refers to different things in the two cases.

As with “individual”, it is unclear exactly what different authors mean by “evolutionary unit”. Some authors argue that species play a theoretical role in the theory of evolution which requires them to be individuals (Hull 1980, Williams 1985). Others say that they are the unit of selection (Gould 2002) or perhaps objects of selection (Mayr, 1997) – this means that species evolve whereas organisms, genes, and other biological entities do not. In some extreme cases, the idea of an evolutionary process is built directly on the idea of what happens to species through time (Eldredge and Cracraft 1980). But whether or not this is accepted, it is normally thought that to be a unit of evolution means that with respect to evolutionary forces – such as a changing environment leading to different selection pressures – the group responds as a single unit with a shared fate (Wiley 1981, Mayden 1997).

While some authors have argued that there are unique, objective evolutionary groups that fit this definition (Simpson 1961, Wiley 1981, Mayden 1997), others point

out that there are no such universal, fundamental units. They hold that there are important, identifiable discontinuities genealogical, interbreeding, genetic, morphological, and ecological groups, but that these do not overlap. Different groups respond differently to different kinds of pressures such that some groups might be a unit with respect to some forces but not others (Dupré 1999, 2001; Mishler and Donoghue 1982; Wilson 2005). Being a unit and responding as a whole also seems to come in degrees such that there will be nested, and perhaps even overlapping groups, which are units to some degree or other. On the face of it, small family units, demes, local populations, and groups of multiple populations all seem good candidates for groups that are units with respect to evolutionary theory. In order to pin down a precise ranking criterion, the vague “coherence” that such groups allegedly have must be specified to some very specific degree which is certainly no easy task.

As with many of the previous debates, we again can avoid answering many of these questions, however important they may be. Rather than determine exactly which groups are evolutionary units, for our purposes, we can simply argue that being an evolutionary unit is not the kind of thing that can generally distinguish species taxa from higher taxa. To do this, I propose to examine a recent paper by Kim Sterelny (1999) which accepts that species are evolutionary units and attempts to draw interesting conclusions from this idea.

8. Species as a grade

Sterelny (1999) talks about species as a grade – a special level of biological organization. In his view, species are evolutionarily linked metapopulations that are ecological mosaics

in just the right kind of complex way such that ecological forces combine to limit the possibilities of change causing this group to be an evolutionary unit.

Sterelny of course recognizes that not all organisms fall into such groups. But, for him, this is an advantage since it allows us to say that there is something special about species. The parallel is that of an organism. Just as organism is a special level of biological organization that not all life divides neatly into, likewise, species is a level that not all organisms fall into. There were times earlier in the history of life when there were organisms but there were no species and there were times earlier than that when there was life but there were no organisms at all. The fact that organisms have special properties allows us to say that they are an important, biological kind. But this view has its consequences. “We cannot both think that all living things are organisms and have a powerful conception of what it is to be an organism” (Sterelny 1999: 122). Sterelny argues, (correctly, I think) that organisms are special kinds of biological entities and therefore is willing to accept the consequences, which turn out to not be so bad in this case.

What is far more controversial is that Sterelny wants to make a tight analogy between organisms and species as special entities. But this has similar consequences. “Equally, I think we have to choose between the ideas that all organisms are members of some species and that being a species is an important biological property, for just as the *organism* is a grade of biological organization that had to be invented, so did the *species*” (Sterelny 1999: 123). Not only were there times early in the history of life where there were no species, but even now, the majority of organisms do not fall into a species. Sterelny recognizes there are *phenomenal* species – discrete morphological clusters

across the whole Tree of Life. But his view of species is not aimed at including these groups. As he argues, there are a variety of forces that cause such discontinuities and there don't seem to be any important properties that all such groups share. If we want species to be a biological kind with important properties that all and only species have, then we can't be concerned about trying to satisfy the criterion that such groups are all species.

On this view, species are ecologically fragmented such that different populations in the same species are under different selection pressures. Gene flow between the populations (called *Mayr's brake* in Sterelny's paper) largely prevents one population from evolving away from the others causing a type of stasis in the properties of the species through time which is reminiscent of the theory of punctuated equilibrium as defended by Eldredge and Gould (1972). This type of complex interaction between populations leads to emergent properties of the species which is what makes them special types of groups.

Sterelny's "species as a grade" view is an exemplar of the view that there is something special about species as opposed to other ranks. Of course one could suggest that genus, family, etc. are grades as well, but Sterelny doesn't do this and to my knowledge no one ever has (though see Wilson and Barker forthcoming about the possibility of treating higher taxa as units of evolution). But the consequences that Sterelny accepts, such as the way in which he denies universalism, make it clear that this is simply not an acceptable view of species *as taxa*.

The idea that all organisms fall into some species or other does seem to be a powerful intuition. But it can certainly be denied. For example, de Quieroz and Gauthier

(1992) recognize that genealogically based taxa will conflict with many existing taxonomic conventions and they allow that not every organism will fit into a species. Rather, they invent the category of “metaspecies” and Baum and Shaw (1995) and Baum and Donoghue (1995) use the same category, although in slightly different ways. But here, metaspecies are only temporary as they exist during what might naturally be called “an extended period of speciation” and they are a natural consequence of the evolutionary process across all branches of the Tree of Life. However, Sterelny does not merely claim that a few organisms are members of transitory groups which cannot be clades in species. Rather, he accepts that most organisms won’t be. In fact, he admits that his theory of species probably applies only in the Metazoa (the multicellular animals) and probably not even universally in the Metazoa.

This is surely unacceptable as a theory of how to rank various groups as species. Clades exist throughout the entire Tree of Life – the Metazoa are a relatively small group in the grand scheme of things. But this is perfectly acceptable as a theory of why certain groups of organisms have special sorts of properties. For example, one can simply deny that plants form the relevant evolutionary units. On the other hand, it would be absurd to deny that there is such a thing as plant systematics which sorts plants into a series of nested taxa, including species.

I think that it is important not to draw the conclusion that Sterelny is simply way off base in claiming that species only exist in select groups of animals and have only come about relatively recently in the history of life on this planet. Rather, we should conclude that Sterelny might very well have a reasonable view of a special kind of biological entity – one that has been called a “species” at least since the Modern

Synthesis. The problem is that the species as an evolutionary unit has been conflated with a taxonomic unit. This important distinction has been noticed before. Mishler and Donoghue (1982) argue that we have a choice between accepting species as evolutionary units or accepting species as taxonomic units and Dupré (1999, 2001) argues for the same point. Each thinks it is obvious that species are taxa – that is, units of phylogeny or units of classification. Certainly, this is closer to the original use of the term. Sterelny's point that we must choose between universalism and species being special biological entities looks like he is making this choice, but I do not believe he is actually even confronting it head on. The words (or even ideas) of “systematics”, “taxonomy”, “phylogeny”, and “classification” do not even come up in Sterelny because he is not even talking about the unit of taxonomy. Rather, he is talking about species as evolutionary units.

Species taxa are the basal unit of a certain biological hierarchy – species, genus, family, etc. The species Sterelny contemplates are in fact the top of a hierarchy consisting of genes, chromosomes, cells, organisms, populations, and species (Wilson 2005 and see Baum 1998 for a related hierarchical picture). These are special kinds of biological entities that have unique properties and can be thought of as grades of organization. It is not a mistake to think that there is such a unit at the top of the hierarchy. The mistake is thinking that the unit at the top of this hierarchy is the same as the unit at the bottom of the taxonomic hierarchy. This is the mistake that Mayr, Ghiselin, Hull, and others make when they assume that what makes species taxa special is that they are cohesive, integrated, individuals that operate as the units of evolution.

9. Getting rid of Species

In the end, individuality turns out not to be the kind of thing that could distinguish species from other ranks. If we are talking about species as taxa, then they are just like other taxa with respect to individuality. On some understandings of individuality, all taxa including species will be individuals. On other ways of understanding individuality, a small number of species may be individuals (and perhaps a few non-species taxa as well) but then this is not the conception that can generally ground the distinction. What we need is a property that all species have that non-species do not have. Individuality is not that property.

On the other hand, we could hold a view of species that simply defined them to be individuals of a certain sort or defined them in a way such that they were guaranteed to be individuals. Species as certain types of evolutionary units or species as a grade of organization might fit this picture. This view makes species very different kinds of things from higher taxa – in fact they are so different that they cannot be taxa at all! In this way of using the term “species”, species is not a taxonomic category. Similarly, it cannot serve as a phylogenetic category since species will not have unique genealogical histories. This turns out to just be an instance of a homonym – the words look the same (“species” and “species”) but they simply do not refer to the same thing. Showing that species as evolutionary units might have properties that higher taxa do not have is not relevant since this does not show what separates the taxonomic category of species from the other categories like genus.

So if we cannot conclude that species are unique simply because they are basal taxa, and we cannot rely on species being unique because they are individuals, what else

could ground the species rank? We could simply attempt to take on possible differences one at a time, but the same responses are likely to come up again and again. Either species turn out not to be special with respect to the property we are examining, or it turns out that if species have the property in question, they would be unsuitable as taxa. Ereshefsky (1991, 1999) and Mishler (1999) examine several other possible distinctions between higher taxa and species, but in the end, conclude that none of the examined reasons will work and it is likely that there simply is no fundamental difference between species and higher taxa. Since there are no important levels in nature that represent the various higher ranks of the taxonomic hierarchy, it is reasonable to suppose that the rank of species does not represent any unique level of nature either.

It is not obvious what conclusions we should draw from our argument that there are no natural divisions in nature which correspond to species taxa. In Chapter 1, I argued that the best way to deal with this for the higher ranks is simply to get rid of them. But there might be some reason to hold onto one rank, even if it is understood to be arbitrary in the relevant way. The term "species" is deeply embedded in biological language and it is a useful term for communication of biological knowledge (Baum 1992, Baum and Donoghue 1995, Cracraft 2000, LaPorte 2007). We could continue to talk about species and try to match them to traditional groups and try to give them their traditional properties as much as possible as long as we abide by certain rules. If they are to be taxonomic units, they must be exclusive groups regardless of what other criteria we demand. With that necessary condition firmly in place, we can use a number of ranking criteria such as interbreeding criteria, or perhaps morphological, genetic, or ecological

similarity. But it would be understood that how exactly to delimit species is a purely conventional, arbitrary matter (Baum ms).

While I believe that this is a perfectly acceptable "solution" to the species problem, there is another, more radical solution which emphasizes theoretical consistency over practicality. On this view, species are just like higher taxa and the species rank is just like all other ranks. By arguing for the meaninglessness of all ranks including species, we are arguing that there really is no such thing as the species category. The existence of the species category means that a "species" is a kind of thing that something can be. This conclusion may seem to carry with it an air of paradox. For example, it is clear that there are such things as potatoes. We could refer to this group of plants with a formal name such as *Solanum tuberosum*. But there is a further question as to whether or not there are such things as species. But how could their not be if there are such things as potatoes? The key is just to focus on the ontological facts about other ranks. We can perfectly well believe in the existence of Primates as a real group without believing that it must be an order rather than a family. In fact, we don't need to believe that there are such things as orders or families at all. But this is no reason to doubt the existence of the group Primates.

If there is nothing that could mark the distinction between an order and a family at all, then it is reasonable to believe that in fact there is no such thing as an order or a family. But we can now extend the argument to the rank of species. As Ereshefsky puts it, if there is no essence to the species category, then there is no such thing as the species category. He then says, confusingly, that species taxa would still exist. But all he means is that many of the things that we have typically thought were species, like the group

Homo sapiens, still exists as a biological entity, but that it isn't a *species* – after all, there are no such things.

The argument against ranks is perhaps best summarized by Hennig: "If systematics is to be a science it must bow to the self-evident requirement that objects to which the same label is given must be comparable in some way" (1966: 154). If we are to call different groups across the Tree of Life genera, they must share something in common. They may all be clades, but this does not distinguish them from other taxa and clearly the mere fact that taxonomists have chosen to call them "genera" does not count. But we can now see that the same point applies to species. We could choose to have a number of different ranking criteria and simply choose by convention which groups we should call species in order to serve various practical purposes. But this does not mean that there is some property "specieshood" that they all share. If the above arguments are correct, there is no such property.

10. Phylogenetics without species

Recall from chapter one that phylogenetic trees can have exclusive groups as tips regardless of their size. For example, Mammalia, Primates, and Apes serve equally well as taxa, but it is traditionally thought that each is really just a collection of species which are the ultimate phylogenetic units. If we kept expanding the tips of the tree, eventually, we would be looking at a tree of all of the species that are contained within the taxa under scrutiny.

But I have just argued that there are no such things as species or at least that there is no objective answer to the question of which groups are species. So what happens to

phylogenetic trees? Nothing at all happens, and in fact the whole theory of phylogenetics is put on firmer theoretical ground by saying that any exclusive groups can serve equally well as tips of a phylogeny, not just groups above the species level. What follows is a worked out example that allows one to see what consequences the arbitrary nature of the species category has on phylogenetic theory.

Mammalian species – especially those closely related to humans – are understood as well as any other species on the planet. One might expect that this would translate into a well-settled taxonomy for the great apes. However, this is not so. For example, as shown in Chapter 1, the genus *Homo* leads to all of the controversial ranking questions that we could possibly want. Of course our varying degrees of anthropocentrism certainly are responsible for many of these problems, but the point is well taken. The obvious question is what information could possibly settle the question of whether *Homo* is in the same tribe as *Pan* or whether they are in two separate tribes? Practical consequences may matter, but there does not appear to be any objectively correct answer that depends on biological facts about the organisms.

This arbitrariness about ranks extends to the species rank. The fossils of close relatives to humans such as *Homo floresiensis* and *Homo ergaster* are notoriously hard to place into species. Some people are splitters favoring differing species designations for nearly every fossil find. Others are lumpers such as Alan Templeton (2002) who argues that all of the variation in fossil finds in the human lineages in the last 600,000 or so years can easily be attributed to variation within a single species so that, for example, the Neanderthals (*Homo neanderthalensis*) as well as a host of others should be considered conspecific with modern day humans.

The case of *Gorilla* is also an interesting one. As with many groups, different taxonomists have classified gorillas in quite different ways and debate continues today (Groves, 2002). It is now basically settled that *Gorilla* represents a genus, but exactly how many species are contained within it is a matter of controversy. Some taxonomic experts list three species, some two and some only one, implicitly treated *Gorilla* as a species not a genus (Groves 1967, Groves 2005, Lecomte et al. 2007). On top of that, there is the problem of classifying the subspecies. Here, it is generally accepted that there simply is no objective standard as to what could qualify as a subspecies, but there are still arguments in the literature as to what would be best. Even among those taxonomists who believe in ranks, subspecies is not a popular one. Many systematists would simply prefer that it go away. The International Code of Zoological Nomenclature does not even recognize the rank of subspecies and so there are no rules as to how it can be used. But the species rank is a whole different story. There are serious debates as to how many species are represented by various Hominin fossils and there are serious debates as to how many species of *Gorilla* there are.

Since the case of *Homo* and *Gorilla* are so controversial, let us look at an instance of taxonomy which is well-settled and as far from controversial as one can be in the area – that of the taxonomy of chimpanzees. Now chimpanzee itself is an ambiguous term like many folk taxonomic terms are. It can be taken to mean the genus *Pan* which consists of two species: the common chimp – *Pan troglodytes* and the bonobo – *Pan paniscus*. But the common chimp itself consists of three subspecies – 1) 2) and 3). There may perhaps be a fourth (Gonder et al. 1997) – such matters are always controversial. The phylogeny of the chimp group looks like this:

Figure 4.1 A phylogeny of the Chimpanzees. Today, this would include two species – one of which has three subspecies.

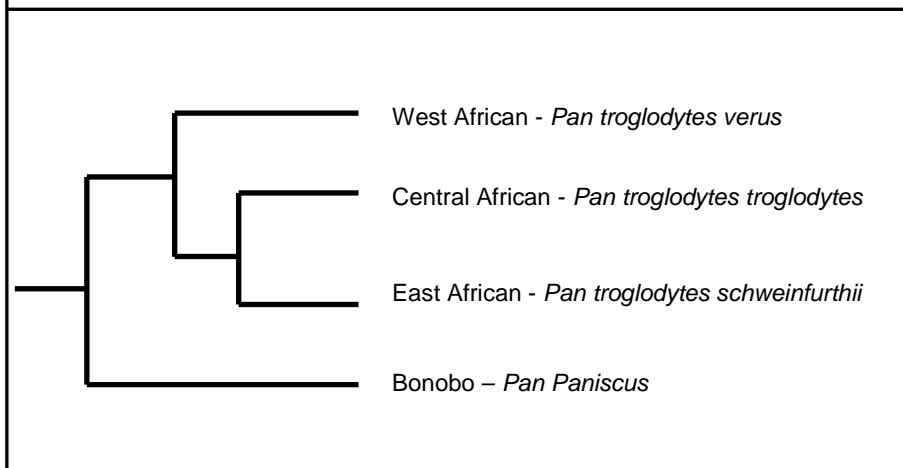

As we can see, first bonobos split off from the common chimp lineage, which has subsequently split into three subspecies. Each subspecies represents a relatively isolated group of populations since major rivers separate them and chimps do not swim.

Although hybrids have been known to occur, most are found in zoos. There are four tips here that we will simply assume each form exclusive groups. There are then three larger exclusive sub-groups represented here: East African + Central African chimp (currently not considered a taxon), the East, Central, and West African chimps (collectively named *Pan troglodytes* and often called the ‘common chimpanzee’) and the group consisting of all four. When the bonobo was first discovered, it was assumed to be another variety of chimp and was referred to as the “pygmy chimp”. What I am suggesting is that there is no theoretical importance to the fact that this group consists of exactly two species. We could be extreme splitters and recognize four species, we could recognize the western

chimp as its own species and then lump the central and eastern chimps together, we can leave the taxonomy as is, or we could lump the bonobos with the common chimp and revert back to our old ways. There are a few unacceptable options such as lumping the bonobos with the western chimp, recognizing the eastern chimp but not the western chimp as a species, etc. In other words, we have a variety of choices, but our choices are limited to classifications that allow only exclusive groups to serve as species. The pattern of phylogeny is the same regardless of how we rank these groups or if we allow rank of subspecies at all. The pattern of our inferences would remain the same as well. If we are concerned about some events such as the evolution of traits that chimps share, we can collapse the chimps into one branch for simplicity or leave the four branches for thoroughness (and to get a slightly larger sample size). If we are dealing with something that may vary between chimp populations, it is essential to make use of the full chimp phylogeny. But there are no inferential purposes that would require us to have a precise ranking of these groups – it is only to deal with questions such as how important we deem the differences between the groups of chimps – something that should not be a part of the fundamental discipline of systematics. As Robert O’Hara puts it – the species problem is something that we have to get over, not something that we have to solve. Understanding the pattern of evolutionary history and diversification is only hampered by the use of ranks – and this includes the rank of species as well.

FIVE

INFERRING PHYLOGENETIC TREES

1. Introduction

Finding the solution to biological problems such as determining whether or not a Florida dentist passed HIV on to his patients (he did – Metzger et al 2002), calculating whether or not brain size and testicle size are adaptively correlated in bats (they are anti-correlated – Pitnick et al 2006), and determining how terrestrial mammals arrived in Madagascar (multiple separate rafting events rather than a land bridge – Poux et al 2005) all require knowledge of the evolutionary history of certain groups. Recovering this history is the project of phylogenetic inference – the goal is to build a phylogeny, or genealogical history, of a group of genes, species, higher taxa, or whatever the objects of study happen to be.

This paper advocates the use of a particular methodology of phylogenetic inference – Bayesian inference. Before I offer any justification for this, I briefly describe the problem of phylogenetic inference and describe Bayesianism in this context. I then provide a minimal defense for the Bayesian approach. For many systematists, the reason to prefer other methods comes not from their belief in the correctness of their preferred methodology, but rather is a response to a supposed problem for Bayesianism – the “problem of the priors.” By correcting serious misunderstandings about this problem and

developing the beginning of a solution, I hope to bolster the overall defense of Bayesian phylogenetics.

In a typical problem of phylogenetic inference, we are concerned with recovering facts about the genealogies of particular biological groups at a variety of levels. The data used to construct these phylogenies can in theory be morphological, ecological, molecular, or any number of different types of information, but the majority of published phylogenies today come from DNA sequences of individual organisms. It is assumed that the true underlying history of these sequences is that of common ancestry and descent with modification. This history is then represented as a binary branching tree. The tips, or “leaves” of the tree are the DNA sequences and the internal nodes represent common ancestors - the points in the past of “coalescence” when the descendant sequences trace back to the same token sequence present in a single individual. Though a conclusion about the phylogeny of species is nearly always drawn, the philosophically minded reader is sure to recognize that moving from a tree of DNA sequences to a tree of another kind such as a species tree requires a conceptual leap; this second stage of inference needs a separate discussion of its own and can safely be ignored here.

The “phylogeny”, the “evolutionary tree”, or just simply “the tree” may or may not contain information such as branching dates, rates of change along branches, or ancestral character states, but it must give at least a branching diagram with the tips labeled. This information uniquely specifies any and all clades, or monophyletic groups, on the tree. This branching diagram is called the tree topology and is generally the primary object of inference for the systematist because knowledge of the topology is a

prerequisite for most further inquiries about the history. Unless specified otherwise, “tree” here refers just to the tree topology.

2. Bayesian phylogenetics

Maximum Parsimony and Maximum Likelihood are two families of methods that have dominated phylogenetics discussion for the past twenty years and both have their advocates (Felsenstein 2004). Although there is a long and rich history of the study of Bayesian statistics generally, it is only in the past ten years that Bayesian methods of inference have been used in phylogenetic studies (Rannala and Yang 1996, Huelsenbeck et al 2001). Bayesianism has taken some time to catch on in popularity and the details and their consequences certainly have not been as widely discussed as those attaching to other methods (Randle et al 2005). For example, Felsenstein in his attempt at a comprehensive textbook *Inferring Phylogenies* (2004) spends only one of 35 chapters on Bayesian methods. However, Bayesian methodology is gaining popularity with time and today it is widely used alongside other methods in published results.

The central idea in Bayesian phylogenetics is that all inferences should be made by utilizing the posterior probability distribution of the trees. Bayes’ theorem has the following consequence:

$$\text{The probability that a tree is correct} = \Pr(\text{Tree} \mid \text{Data}) = \frac{\Pr(\text{Data} \mid \text{Tree}) \times \Pr(\text{Tree})}{\Pr(\text{Data})}$$

given the sequence data that we have

$\Pr(\text{Tree})$, called the prior probability of the tree, is determined from a probability distribution over all possible trees given before the data are examined. The probability of

the data – $\Pr(\text{Data})$ – is a normalizing constant simply used to make sure that the posterior probabilities sum to 1. It is equal to the sum of the probabilities of getting the data on every possible tree weighted by the particular tree’s prior probability. Labeling each tree topology as T_1, T_2, \dots, T_i , we have:

$$\Pr(\text{Data}) = \sum_{T_i} \Pr(\text{Data} | T_i) \times \Pr(T_i)$$

$\Pr(\text{Data} | \text{Tree})$ is called the likelihood of the tree, but it cannot be directly calculated since the tree topology alone does not give us sufficient information to assign a probability to the data. Rather, we need additional information such as the branch lengths (the expected number of changes per site along a particular branch) along with some model of evolution that will contain its own parameters to be estimated such as the nucleotide substitution rates.

The Bayesian method for dealing with these nuisance parameters (parameters that aren’t of primary interest) is to “average over” them by integrating them out. In the frequentist method called “Maximum Likelihood”, for each tree, nuisance parameters such as branch lengths and substitution model parameters are set at the value that would maximize the probability of the data on that particular tree. The Maximum Likelihood tree is by definition the tree which is a conjunct in the tree-plus-nuisance-parameters conjunction which makes the data most probable. Thus, confusingly, the likelihood of the tree used in Bayes’ Theorem is not the same as the tree’s Likelihood score used for Maximum Likelihood inferences.

Treating nuisance parameters in the Bayesian way, if we denote a fixed set of branch lengths as v and a fixed set of parameter values of the model as θ we now have:

$$\Pr(\text{Data} | T_i) = \int_v \int_{\theta} \Pr(\text{Data} | T_i, v, \theta) \times \Pr(v, \theta | T_i) dv d\theta$$

Substitution in both the numerator and denominator yields this formula:

$$\Pr(T_i | \text{Data}) = \frac{\int \int_{v, \theta} \Pr(\text{Data} | T_i, v, \theta) \times \Pr(v, \theta | T_i) dv d\theta \times \Pr(T_i)}{\sum_{T_i} \int \int_{v, \theta} \Pr(\text{Data} | T_i, v, \theta) \times \Pr(v, \theta | T_i) dv d\theta \times \Pr(T_i)}$$

The above formula tells us the posterior probability of any particular tree hypothesis. If we are interested in something else, say the probability that a particular group forms a clade, since this is, in effect, a large disjunction (the true tree could be any one of the trees that contains that clade), the posterior probability of that clade is simply the sum of the posterior probabilities of all trees which contain that clade. The probability distribution of any other parameters such as a branch length, the individual substitution rates, or the ratio of transitions to transversions are all similarly calculated. The Bayesian philosophy thus provides a framework for answering a host of relevant theoretical questions all at the same time. Of course actually calculating the full posterior distribution is another matter. However, there is reason to be hopeful here. Computational methods for numerically estimating multi-dimensional integrals are quite advanced. The standard idea is to use Markov Chain Monte Carlo (MCMC) methods to estimate the posterior distribution. For an introduction to these methods in phylogenetics see Larget and Simon (1999) and Larget (2005).

How we can actually infer the posterior probability and how we can do it in a computationally efficient manner are important practical questions, but it is to the theoretical issues that I now turn. These questions assume that we have access to the various posterior probability distributions and ask why we should use these to make our phylogenetic inferences rather than use some other quantity. If there are deep theoretical

problems with Bayesian methodology, it hardly matters if we have an efficient way of calculating the relevant probabilities.

One important, though hardly decisive, consequence of Bayesian methodology is the ease of interpreting results. Since the posterior probability of a tree just is the probability that the tree is correct (given our data and our model of evolution), the tree with the highest posterior probability is the tree which is the best supported. In fact, the strength of its support is measured directly by the posterior. Other facts about the problem, such as which tree would require the fewest nucleotide substitutions, which is what the Parsimony score captures, are of interest only in so far as they are a reliable guide to which tree is true (which they often aren't).

In addition, unlike other methods, we can judge the strength of the evidence for all aspects of the tree at the same time without needing to reanalyze the data using different techniques. The probability that a particular group forms a clade, that two particular sequences have coalesced in the last one million years, that sequence A is more closely related to B than to C, or any other question about the tree is measured using the posterior distribution. None of these problems are easily analyzed with other methods which are usually designed just to find the best topology. While particular tests have been developed (see Felsenstein (2004) for a host of examples) none has a straightforward statistical interpretation that is useful and as such they generally appear to be disjoint, ad-hoc tests with no underlying, unified justification.

While a theoretical justification can be constructed for using posterior probabilities to guide our inferences, I will not attempt to do so here (for that and a host of similar references, see Howson and Urbach (2005)). Rather, I will focus on a few

reasons why one might object to Bayesianism in this context. Some systematists believe that probabilities and perhaps even all statistical methods simply cannot be used to make inferences concerning a particular group's evolutionary history since it is a "unique event" – meaning it has occurred only once (Siddall and Kluge 1997, but see Haber 2005) or believe that Parsimony has some special justification apart from its statistical behavior (see Farris 1983, Kluge 2005 or any of a host of papers in-between, but see Sober 1988). From those who are more statistically minded, there are worries that the posteriors might be overly sensitive to the choice of an evolutionary model or that Bayesian inference treats nuisance parameters as random variables and thus is not properly frequentist as Maximum Likelihood appears to be (though see Yang 2006). While these are important objections, they have been dealt with elsewhere (besides the above references, see for example Huelsenbeck and Ronquist 2005) and I will not discuss them further.

While there are certainly more issues to discuss, the central problem which has yet to be adequately dealt with and is perhaps the most common objection to Bayesian phylogenetics and to Bayesian inference more generally is the "problem of the priors" – how to assign prior probabilities to the hypotheses under test. As Felsenstein, an advocate of frequentist methods, puts it: "If the prior is agreed by all to be a valid one, then there can be no controversy about using Bayesian inference" (Felsenstein 2004:300). While there would of course still be controversy, his point is that to the statistically minded theoretician, there shouldn't be.

While a subjective Bayesian may respond that prior probabilities ought simply to represent the prior beliefs of the particular investigator, it is certainly a worthwhile project to attempt to model a certain kind of ignorance for the use of priors. This is a

direct attempt to avoid biasing the results in favor of our prior conceptions. After all, we want results that ought to be taken seriously by a wide range of scientists and we may want to know what “just this data” should lead us to believe. This is one of the goals of so-called “objective Bayesianism” (perhaps better called “Interpersonal Bayesianism” – Kadane 2006). As long as we have a proper understanding of ignorance, it would appear, at least in certain cases, that we should attempt to model ignorance in the priors. But there are many things that we appear to be ignorant about – the tree topology, its branch lengths, which groups form clades, etc. It might seem that modeling ignorance with respect to some of these factors is simple – for example, to model ignorance with respect to tree topologies we should assign equal prior probabilities for all topologies. This distribution is called a uniform prior on topologies. However, there are many different ways of conceiving of a tree. The shape of the tree refers to the branching diagram with no labels at the tips and so has less information than the topology. The topology is simply an unlabeled shape with labels added to the tips. In addition, we may be interested in more than just the topology. The labeled history (sometimes called “ranked topology” – e.g. Semple and Steel 2003) refers to the topology plus a temporal ordering of the nodes. These differences will become important later; they are depicted in Figure 1.

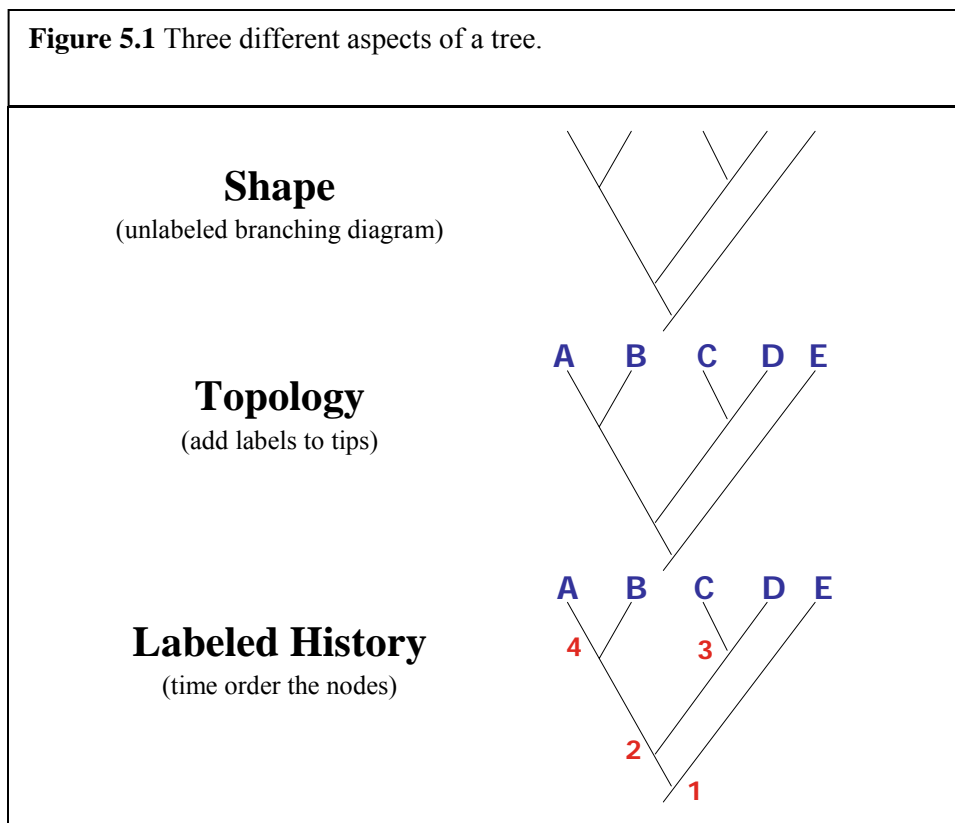

To get a topology from a shape, labels are added to the tips. In this example, if “B” and “C” were switched, we would have the same shape but a different topology. Recall that topologies do not specify the time at which the nodes occur. In a labeled history, the nodes are labeled to represent their relative temporal ordering. In this example, C and D split from each other (node 3) before A and B split (node 4). If “3” and “4” were reversed, we would have the same topology but a different labeled history.

Some shapes are consistent with more topologies than others; if each topology has an equal prior, not all shapes will be equally probable. Similarly, some topologies are consistent with more labeled histories than others so assigning equal priors to all topologies means that not all shapes nor all labeled histories will be equally probable. This is apparently a problem since it would appear that we are ignorant with respect to each but yet we cannot model ignorance with respect to all three. However, I suggest that this way of thinking about ignorance is a mistake. We are not ignorant of *everything*

regarding topology and shape – after all, we know the logical facts that connect them. The kind of ignorance we ought to be modeling does not always lead to uniform priors. As an example of what I mean, I now turn to a recent example that purports to show that the use of priors in phylogenetics inevitably leads to biased results.

3. Priors on clades

Nearly every published paper using Bayesian methods uses a uniform prior distribution on tree topologies which assigns equal prior probability to each possible topology. Partly this is motivated by the simplicity of the proposal combined with its being the only distribution available (other than entering your own constraints for particular clades) in popular computer programs such as Mr. Bayes (Huelsenbeck and Ronquist 2001). And without careful examination, the proposal does seem sensible – after all, why should we have a prior preference for one topology over another when the topology itself is the primary object that we are trying to infer? In fact, by not using priors at all, if used as a guide to truth, Parsimony and Likelihood analysis are carried out in a way that effectively treat all topologies as equally probable a priori. This fact has not been traditionally seen as biasing results in any way. But as Pickett and Randle (2005) (henceforth “P&R”) point out, a uniform prior distribution on topologies implies a non-uniform distribution on the prior probabilities of clades – in particular, the probability that a particular group forms a clade depends on its size relative to the total number of taxa in the analysis. Smaller and larger groups have higher probabilities while middle-sized groups have the lowest probabilities. Figure 2 provides an example, when sets of different sizes are drawn from 50 taxa placed at the tips (or “leaves”) of the tree.

Figure 5.2: A graph depicting the probability that a group of a given size forms a clade on a tree with 50 taxa when a uniform prior on topologies is used.

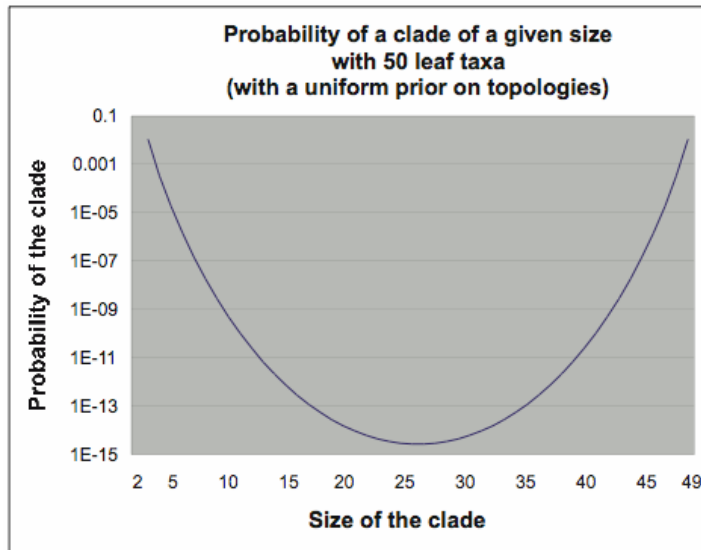

While the particular values would change with a different number of taxa in the study, the shape of the curve will not. Any arbitrary group of taxa is a possible clade and P&R contend that all such groups regardless of their size should have the same prior probability of forming an actual clade in a given problem with a fixed group of taxa. Analyzing simulated data as well as data from seventeen published empirical studies, P&R argue that the use of the uniform distribution has biased the posterior probabilities in predictable ways, namely, that the very smallest and largest clades typically have the highest posteriors probabilities and the middle-sized clades have the lowest. This result corresponds to the prior distribution on clades imposed by setting a uniform prior over topologies. Several subsequent papers and books have cited this fact (e.g. Goloboff and Pol 2005 and Yang 2006) and different examples have been produced which lead to the

same results. The authors agree that these facts lead to devastating conclusions for the Bayesian.

This line of thinking is based on misunderstanding what it is for the posterior to be biased and what the appropriate understanding of ignorance is. It is entirely proper for different sized clades to be more or less probable a priori since the appropriate understanding of a priori in this context builds in relevant background knowledge. P&R's claim that you can't have both uniform priors on topologies and on clades is correct; in fact, Velasco (2007) strengthens their proof by showing that on any probability distribution on trees (not just the uniform one) not all clades can be equally probable. There is nothing special about the uniform prior on topologies which conflicts with uniform priors on clades – uniform priors on clades is simply inconsistent. Having every possible clade be equally probable is not something that we could have even if it were desirable (which it isn't.) Once we see why this is so, it becomes easier to see what conclusions we should draw from it.

There is an easy explanation for why it is impossible for every possible clade to have an equal probability of forming an actual clade on the true tree. In a given problem with a fixed set of taxa, the probability that a group of a particular size forms a clade is just the expected number of clades of that size divided by the number of possible clades of that size. Lets use two specific sizes (clades of size 2 and 3) as examples to show that they can't be equally probable. The fact that not all of the probabilities can be equal can be deduced from the following two facts:

1) Since smaller clades are nested inside larger ones, on any tree (and therefore on the true tree), there are at least as many actual clades of size two as there are of size three.

Therefore, on any probability distribution over trees:

the expected number of clades of size 2 \geq the expected number of clades of size 3.

2) When there are at least five leaf taxa:

the possible number of clades of size 2 $<$ the possible number of clades of size 3.

Therefore, (when we have at least five taxa),

$$\frac{\text{the expected number of clades of size 2}}{\text{the possible number of clades of size 2}} \neq \frac{\text{the expected number of clades of size 3}}{\text{the possible number of clades of size 3}}$$

So not all possible clades of size two or three could be equally probable and *a fortiori* not all possible clades can be equally probable.

To determine the actual numerical probabilities, we need to know two things: the numbers of possible and actual clades of each size. The number of possible clades of size x is just the number of possible ways of choosing a group of size x from the collection of

n taxa which is just n choose $x = \frac{n!}{x!(n-x)!}$. The number of actual clades of a given size

will depend on the tree. A uniform distribution on tree topologies yields a particular distribution on the expected number of clades of any particular size first calculated in Brown (1994). The above facts are perhaps more easily appreciated by attending to the following graphs in Figure 3:

Figure 5.3: Two graphs comparing the number of possible clades of a given size to the expected number of clades of that size. The expected number of clades (the value on the right) divided by the number of possible clades (the value on the left) is the probability that that group forms an actual clade. This figure is taken from Velasco (2007).

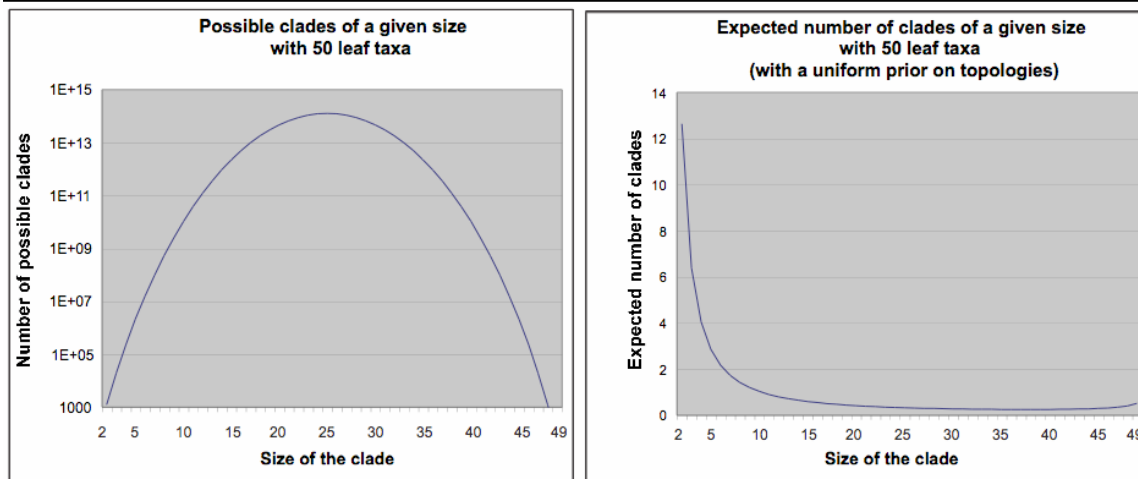

The first graph plots how the size of a clade determines the number of possible clades of that size. I have used $n = 50$ taxa as an example, but the shape of the curve is the same for any number of taxa. Notice that the scale is logarithmic meaning that there are vastly more possible clades of size 25 than, say, size 10. The second graph plots how the size of a clade determines the expected number of clades of that size on the uniform distribution on topologies. Since the probability of a clade is just the expected number of clades of that size divided by the number of possible clades of that size (assuming all clades of the same size have the same probability), if the probability of a clade is to be the same for every size, these two curves must have the exact same shape (one should be the other multiplied by a constant – the probability). Notice that the "expected clades" curve is calculated under a uniform prior on topologies (as in Picket and Randall 2005) – for other topology distributions the curve varies in shape slightly, but a few aspects remain

constant, such as the fact that its peak must be at size 2. Since no distribution on trees gives it the same shape as the “possible clades” curve, the probabilities of all possible clades can never be identical. A formal proof of this fact is given in Velasco (2007).

So what should we make of this theorem? It might be thought that we have just shown that Bayesianism is a flawed methodology. After all, haven’t we just shown that it is impossible to model ignorance with respect to clades since clades of different sizes must have different probabilities? And isn’t this obviously bad? As P&R put it,

Few, if any, systematists believe a priori that the probability of monophyly has anything to do with the number of taxa hypothesized to be monophyletic. Certainly, the prior assertion that small clades and large clades are more probable than mid-sized clades lacks biological relevance. As such, a return to optimality per se is warranted. (Pickett and Randle, 2005:209)

P&R as well as Goloboff and Pol (2005) and Yang (2006) claim that uniform priors on topologies introduce a bias in favor of smaller and larger clades and against medium sized ones. We have just seen that this disparity in probabilities is guaranteed to occur regardless of our choice of priors on trees. Their choice of the word “bias” indicates that they think that this is a bad thing. P&R think this justifies abandoning Bayesianism as it is currently practiced and they suggest three alternative, incompatible methods for being Bayesian while attempting to artificially “correct” for this bias. However, their conclusion that using priors introduces an unacceptable bias into the problem rests on a mistake. We *want* the probabilities of clades to depend on their size. Artificially changing the posteriors or altering how we measure the strength of the evidence to correct for this would actually *introduce* bias. There *is* biological relevance to the fact that clades of size two should have higher priors than those of size three – we know from the way that clades are produced that clades with larger numbers of taxa have smaller

clades within them. Basic mathematical facts combined with background biological facts indicate that we *should* believe that groups with more taxa are less likely to be clades.

Claiming ignorance with regard to whether the true tree contains a particular clade of size two or whether that tree contains a particular clade of size three is like claiming ignorance with respect to whether some random integer is divisible by 2 or divisible by 4. Ignorance does not entail equally probable.

To head off a possible response, notice that the idea of clades nested within clades explains why smaller clades should be more probable, but this doesn't explain why larger clades also have higher priors. But this is not a problem. The high probability of very large clades is simply an artifact of the design of the problem. If our problem uses 10 taxa, for 9 of them to form a clade, all it takes is for the tenth to be outside of the rest. However, that same group of 9 taxa is much less likely to form a clade if the problem considered 50 taxa. Unlike a problem with 10 taxa, with 50 taxa, clades of size 8 are more probable than clades of size 9. The bias toward very large clades essentially comes from assuming that all taxa under consideration form a clade. Just as the conditional probability that A and B form a clade is relatively high given that A, B, and C do, the conditional probability of 9 taxa forming a clade is high given that we are acting as if they are inside a clade of 10 taxa. This fact is more easily appreciated by recalling that "forming a clade" is only meaningful in the context of a particular problem. For a group to form a clade in a particular problem, the members of the group must be more closely related to each other than to any other taxa under consideration. Humans and Gorillas form a clade as long as Chimpanzees are not one of the taxa under study. There is nothing objectionable about this either.

This argument shows that the probability of a clade must depend on its size, but if we do not carefully formulate the question, there might appear to be obvious counterexamples. If we think of particular groups, it is tempting to conclude that P&R might be correct after all – for example, what should the prior probabilities of monophyly be for the following groups: apes, mammals, and vertebrates? According to the above reasoning, the prior on apes should be low, mammals extremely low, and vertebrates unbelievably tiny. But our actual confidence in the three groups doesn't appear to depend on size. So are P&R correct after all? No. There are several problems with the supposed analogy, but the major statistical error is that this is an instance of sampling bias. Ignore the fact that many systematists would simply define these groups in such a way as to guarantee that they are monophyletic and imagine that we are working with a more traditional definition based on characters – or think of “vertebrates” as rigidly designating some set of taxa which we currently believe are vertebrates. The sample is biased because we have selected clades that have a high *posterior* probability of being monophyletic and then we are asked to imagine what their *priors* should be. For example, they each have what appear to be uniquely derived characters. Of course clades of different sizes can have the same posterior probabilities. But this is not the claim. P&R are claiming that *before* we examine *arbitrary* groups of taxa that we know nothing about, we should be equally confident that they are monophyletic regardless of their size. But this is absurd. Imagine I assign each of 100 primate species a different number and then randomly select some of those numbers. What are the chances that the numbers I have selected pick out a monophyletic group? The chances will obviously vary with the number of taxa that I select. If I select two primate species at random, the

odds that I have selected a monophyletic group are low, but they are vastly higher than the odds that I have selected a monophyletic group if I had selected fifty random species. Yet this is exactly analogous to the question under consideration. Size does matter.

4. Possible Priors and the Principle of Indifference

The above argument shows that we have to be careful when we wish to model ignorance, but it does not tell us how we actually ought to do so. We need to further constraints to guide our priors. The above arguments only show that clades of different sizes should have different probabilities, but it is correct that in order to avoid bias all possible clades of size two should be equally probable, all possible clades of size three should be equally probable, etc. In other words, if we ask some question about a group of n taxa that are otherwise unknown to us, it shouldn't matter which n taxa we select. If we want to know the probability that A is closer to B than to C or that A and B coalesce in the past million years, it shouldn't matter which taxa A, B, and C represent. Distributions that satisfy this condition are called label-invariant. If we want to model ignorance with respect to the particular taxa we choose, we must use a label-invariant prior. While this is certainly helpful, it still leaves us with an infinite number of choices. For example, a uniform prior on topologies satisfies this condition, but so do many distributions that entail that some shape has probability one. While these second types of distributions are certainly implausible, we can't rule them out simply on the basis of the condition that we must treat each taxon equally.

Although uniform priors on topologies are typically used, we have already seen that several authors believe that it leads to biased results that can be uncovered by

examining other factors such as particular clades. While unequal priors on clades are not a good reason to give up uniform priors on topologies, perhaps looking elsewhere will provide just such a reason. For example, with four taxa there are 15 different topologies – 12 have the pectinate $A(B(C,D))$ shape (this notation means that C and D form a clade which is nested inside B, C, and D which form a clade) while only 3 have the balanced $(A,B),(C,D)$ shape where there are two clades of size two. So uniform priors on trees introduces a skewed distribution on shapes. Is this acceptable? A traditional defense for uniform priors on topologies might appeal to the principle of indifference – when there is no epistemic reason to prefer one topology over another, they should all have equal priors. Of course most versions of the principle of indifference have well-known problems and typically lead to inconsistency (Joyce 2005), but there may be some less general principle which applies in this case that isn't problematic. But even a principle tailored specifically for phylogenetics is going to be question-begging in this context as the obvious response is that there is a reason to weight topologies differently – namely, some shapes are consistent with more topologies than others. If we believed that shapes should be equally probable, this (together with label invariance) would determine a particular distribution on topologies that favors topologies that are more balanced. In addition, we might also wish to assign equal probabilities to each labeled history. Each distribution is different so which distribution is to be preferred?

In other cases in science where we think that there is a good answer to this type of question, the correct prior is always determined by looking at the physical process that generates the values for the probabilities. In many cases, the process can vary. Selecting a day “at random” might yield a prior probability of $1/365$ for any particular day being

selected, but if the process of selection involves first selecting a month at random and then selecting a day within that month, the probabilities would be different. Regardless of the process, the point is that if we know the method of selection, then we can determine how to model ignorance. Assigning priors is problematic only in cases where we do not have an understanding of the underlying process.

In the phylogenetic case, the tree is a result of the biological process of common ancestry and descent with modification. We want to know the probability distribution that results when a tree is produced by this process. Trees are the result of the sequences passing down from organism to organism via reproduction on the branches and splitting at the nodes when the organism gives rise to multiple offspring which lead to different, extant taxa. A perfectly random branching process is captured by the Yule birth process in which particles reproduce with a constant probability of giving birth per particle per unit time so the Yule birth process seems the ideal place to start our investigation.

5. The Yule Process

In 1925, G.U. Yule developed a statistical model to help explain why some genera have many more species than others (Yule 1925). The model was based on thinking of speciation as lineage splitting – one lineage gives birth to another without dying. In the simplest case, the idea is that we start with a common ancestor and then the probability of any particular lineage splitting in some small unit of time is the constant λdt . Two splitting events happen in the same time period with probability $o(dt)$. As time passes, there are more and more lineages present, each with the same probability of splitting until

we reach the final result of n taxa. If at each slice of time, each existing lineage has an equal chance of splitting, we call the process a Yule pure birth process.

Another way to think about this process is by looking at the present and working backwards. The coalescent process imagines n gene sequences existing at the present. Then as we move back in time they will begin to coalesce. Each sequence has an equal probability of coalescing with any other particular sequence and then we go from n to $n-1$ sequences and repeat the process again. This process is obviously just the inverse of the birth process and so the same mathematical rules apply yielding the same probabilities for certain parameters such as shape and topology (Kingman 1982).

For our purposes, we want to know the probability of getting a particular tree as the result of a Yule process. The answer is that a Yule process produces each labeled history with equal probability (Edwards, 1970). Thus the distribution that each labeled history should be equally probable a priori can be given a justification. The justification is not the one provided by the principle of indifference, which says “I can’t think of a reason why one labeled history should be more probable than another.” Rather, the justification is that if the evolution of different taxa is the result of random lineage splitting, then for n random taxa, the probability that they form a particular tree topology is proportional to the number of labeled histories that are consistent with that topology.

One might be worried that we are ignoring extinction. We could easily add another parameter μ where the probability of any particular lineage going extinct is μdt . This is known as a birth-death process. Importantly, it leads to exactly the same distribution on tree topologies. As long as the extinction happens randomly across lineages, the prior probabilities will be the same (Thompson 1975). The pure birth

process, the birth-death process, and the coalescent process all lead to exactly the same distribution – all labeled histories are equally probable.

The idea that the Yule process represents a “randomly branching tree” is not new in the mathematical literature (Harding 1971, Aldous 2001). This idea is also fairly standard in the biological literature. The Yule birth process (or more typically a birth-death process) is widely used to study macroevolutionary trends. For example, the discovery of broad-scale biogeographical patterns and the detection of differences in speciation or extinction rates across lineages are standardly thought to depend on comparing the accepted phylogeny to a null model of random branching. The null model typically used for such comparisons is the Yule model (e.g. Mooers and Heard 1997 and many of the very large number of references therein). The Yule process is also widely used to study microevolutionary processes. The standard method of studying intraspecific diversity will use a coalescent process to build gene genealogies which are essential to testing hypotheses such as those concerning the strength of selection at a particular site or testing the amount of gene flow between distinct populations (Halliburton 2004, Hein et al 2005). Despite the near-universal acceptance of the Yule process being the underlying physical process for common descent and therefore the production of phylogenetic trees, biologists virtually never take this process into account when actually constructing trees! (For exceptions, see Rannala and Yang 1996 and Yang and Rannala 1997.)

The use of prior probabilities in Bayesian phylogenetics makes thinking about the probabilities of trees unavoidable, but the idea of a null model for a tree is required even in methods that do not specifically attempt to use a prior probability distribution. As we shall see later, ignoring these facts can lead to mistaken conclusions not only in

constructing trees which are best supported by the evidence, but also when we attempt to use those trees to make further inferences about the evolutionary process. Theoretically, it is well motivated to start insisting on such a change in methodology, but I now turn to the question of what, if any, consequences making such a change will actually have.

We have already noted that the “Yule distribution” – the probability distribution of trees induced by a Yule process – is a different distribution than the uniform distribution. With four taxa, there are 15 topologies and 18 labeled histories. Since some topologies (those with the pectinate, asymmetric shape) are consistent with only one labeled history and some are consistent with two (the balanced shape), the priors shift from $1/15$ on the uniform topology to either $1/18$ or $2/18$ depending on whether we are looking at the asymmetric or the balanced tree. In general, more asymmetric topologies will have their prior probabilities lowered and more balanced trees will have theirs raised. There are many ways that the overall balance of a tree could be measured (Mooers and Heard 1997), but certainly in the clear cases, the result of a Yule process is that a tree that is more balanced will be consistent with more labeled histories (there are more pathways to reach it) and thus is more probable than any particular unbalanced tree.

The idea that balanced trees are consistent with more labeled histories and therefore are more probable than unbalanced trees is exactly analogous to the claim that if we flip a fair coin 100 times, we are more likely to get 50 heads than some other number of heads. If the coin is fair, each particular sequence of heads and tails is equally probable. Since 0 heads is only consistent with one sequence, it is far less probable than 50 heads which is consistent with $\approx 10^{29}$ sequences. An important side note is that we should not conclude that the Yule process will probably result in a balanced tree. The

appropriate conclusion to draw is that $\Pr(T_1|T_1 \text{ is balanced}) > \Pr(T_2|T_2 \text{ is unbalanced})$ not that $\Pr(\text{Tree will be balanced}) > \Pr(\text{Tree will be unbalanced})$. Far fewer tree topologies are balanced than unbalanced, so even though each has a higher probability than those that are unbalanced, the unconditional probability that a tree is balanced is still relatively low.

So we know that if we replace uniform priors with Yule priors, the prior probabilities of unbalanced trees will go down while those of balanced trees will go up. But does this difference really matter to their posterior probabilities? This will depend on the particular problem. Problems can be constructed where the priors matter. Problems can be constructed where they don't. With enough data, the likelihoods of the various trees will completely swamp differences in the priors between trees. But how much data is required and just how much this difference in priors matters in realistic cases is something that will require careful quantitative investigation.

It is widely known that the number of possible trees with n taxa =

$2n - 3!! = \prod_2^n 2n - 3$ (Felsenstein 2004). Steel and McKenzie (2001) provide a recursive

algorithm for calculating the number of labeled histories consistent with a particular

topology. For each vertex v (node) let $\delta(v)$ be the number vertices that are its

descendants (including itself). Note that this is the same as the number of taxa in the

subtree formed by that node minus 1. Now, the number of labeled histories consistent

with any particular tree topology = $\frac{(n-1)!}{\prod_v \delta(v)}$. For example, the number of labeled

histories consistent with the perfectly balanced 4 taxa tree = $\frac{(4-1)!}{3 \times 1 \times 1} = 2$. Combined with

the formula for the total number of possible labeled histories for n taxa: $\frac{n!(n-1)!}{2^{n-1}}$

(Edwards 1970) we now can calculate the prior probability of any particular tree under the Yule model. To see directly whether this will affect the posterior probability of any individual tree, we would need to calculate the normalizing constant – $\Pr(\text{Data})$ – which we can't do. Another option is to run an MCMC on some particular data set with uniform priors as is typically done and then run the MCMC on the same data set with Yule priors instead of uniform priors and simply check for differences in the results. This method requires us to recalculate the entire posterior distribution just to see if there will be any significant difference in the posteriors of particular trees. But there is another method that can tell us at least some of what we want to know.

Imagine that we perform the calculations with uniform priors and get the result that T_1 has a higher posterior probability than T_2 . How probable is it that the results would be different if we used Yule priors instead? For the order to switch, the ratio of the posteriors would have to switch from being greater than 1 to being less than 1. By Bayes Theorem, the ratio of the posterior probabilities is equal to the ratio of the priors times the ratio of the likelihoods:

$$\text{Bayes Theorem (Odds-Ratio form)} \quad \frac{\Pr(T_1 | D)}{\Pr(T_2 | D)} = \frac{\Pr(D | T_1)}{\Pr(D | T_2)} \times \frac{\Pr(T_1)}{\Pr(T_2)}$$

Since the likelihoods themselves will not change, we can directly calculate the effect of changing the priors. Since the old prior ratio was 1:1, if we want to switch the ordering on trees, we need the new prior ratio to be greater than the reciprocal of the likelihood ratio. So how large is the ratio of the priors? In the 4 taxa case, the most balanced to least balanced ratio is only 2:1. But like all other effects that depend on the number of

possible trees, this is going to increase combinatorially. To give an extreme example, the perfectly balanced tree with 64 taxa (it splits into two subtrees of 32, each of those splits

into two subtrees of 16, etc.) is consistent with $\frac{(63-1)!}{63 \times 31^2 \times 15^4 \times 7^8 \times 3^{16}} \approx 2.61 \times 10^{63}$

labeled histories. Since the maximally unbalanced tree, which has splits of 1:63 then 1:62, then 1:61, etc., is consistent with only one labeled history, 10^{63} is also the ratio of the prior probabilities of the trees. For $n = 128$, this ratio rises to $\approx 4.1 \times 10^{163}$. While the likelihood ratio can easily be greater than this for several thousand independent sites, these massive numbers should certainly give pause to anyone who claims that using different priors would not make any difference. Certainly they will make *some* difference to the overall posterior distribution. Exactly how much difference they will make will depend on the particular case and general conclusions will require further study.

Regardless of how often changing the priors dramatically affects the posteriors, we have at least the beginnings of an explanation of why we should use one prior probability distribution rather than another.

An important feature of this discussion is that it is not essential to this argument that the Yule process perfectly captures the causal process by which evolutionary trees are produced. In particular, it is clearly unrealistic that at a given time, each extant lineage has the same probability of splitting. This paper takes the important first step of using priors that at least attempt to be biologically relevant. There is no known biological process that would lead to a uniform distribution on topologies. As such, there can be no justification for using these priors. In addition, we can think of the Yule model with no other effects as the simplest among a whole class of branching models which might be used to generate priors. Further biological investigation can help us improve our

branching models and thus improve the accuracy of our prior probabilities. The Yule model, not the uniform model, will form the essential backbone of any such future investigations.

In addition, it needs to be pointed out that Yule process models how *all* of the tips resulting from a common ancestor are expected to be related. This means that taxa sampling will severely affect the model. If we are examining all of the tips that have descended from some ancestor, then the Yule process will be adequate. Similarly, if we randomly sample tips, this will not affect the distribution. However, if we use some non-random method – such as sampling two organisms from each species under investigation – it is easy to see that we should expect the tree to have a different shape. A clear instance of this is the use of outgroups which guarantees that the tree will be very imbalanced at the root – something that is improbable on a Yule model. Depending on how we sample, we might be able to correct this bias (in the two above cases, this is easy). But often times, we sample taxa non-randomly – such as when we examine the relationship between the groups that seem most interesting to us – but this sampling process is not something which we can build into our model by specifying priors. This entire discussion simply reinforces the point that it is essential to realize that not all trees are equally probable a priori and that this fact can affect our results when it is ignored.

6. The Base-Rate Fallacy

Since using different priors on topologies could lead to different results in particular phylogenetic studies, it could also lead to different results in studies that use phylogenies to make further biological inferences. This is particularly relevant since I have argued

that phylogenies produced without attending to the Yule model are not just in error, but that they are in error in a particular way. I will now examine an example of this error.

The base-rate fallacy is a common mistake made in everyday reasoning. That mistake is to ignore the base-rate, or prior probability, of events when making inferences. Here is a standard example of medical testing often found in the literature.

We take a random person in the United States and administer an HIV test which is accurate in 95% of all cases. The test shows up positive. The proper conclusion to draw is that this person probably does not have HIV. We can reach this conclusion by noting that the prior probability that they have HIV can be approximated by the base-rate of HIV in the population. In 2005, the CDC estimated that there are about 438,000 people living with HIV out of over 300 million in the US and its dependencies giving us a prior probability of .00146 (Centers for Disease Control and Prevention 2005). By Bayes' Theorem,

$$\Pr(\text{HIV} \mid +\text{test}) = \frac{\Pr(+\text{test} \mid \text{HIV}) \times \Pr(\text{HIV})}{\Pr(+\text{test})} \approx \frac{0.95 \times 0.00146}{(0.95 \times 0.00146) + (0.05 \times 0.99854)} \approx 0.027$$

In other words, there is only a 2.7% chance that this person actually has HIV. The explanation is simple – 5% of the people who don't have HIV will get a positive test result and this group is much larger than the group of individuals who actually have HIV. Certainly, the positive test result raises the probability that this person has HIV. In fact, it raises it by a factor of almost 20 – but this only raises the probability from 0.15% to about 2.7%. In general, if the false-positive rate is higher than the base-rate, then there will be a less than 50% chance that they actually have the disease in question. If we look at only the likelihood of having HIV (0.95) and ignore the base-rate, we are committing the base-rate fallacy. While ignoring very skewed base-rates is particularly bad, it is

important to realize that it is always an error to ignore base-rates regardless of what they are.

While the debate over how to assign prior probabilities might be seen as a debate internal to Bayesianism, understanding the underlying process that generates phylogenies is essential to making correct inferences regardless of methodology. If the Yule process truly underlies the production of phylogenetic trees, then to ignore it as Parsimony and Maximum Likelihood methods do is akin to committing the base-rate fallacy. Similarly, using a prior distribution, but using the wrong one such as when the uniform distribution is used, leads to the wrong conclusions. If we are lucky enough to have data which show a very strong signal for particular clades, the data will overcome the bias that these mistakes introduce, but this will certainly not be the case in every instance.

As a practical example of this error, there is a large literature on how to make inferences based on the shapes of trees and the consensus in the field is that trees (based on published phylogenies) seem to be more asymmetric than we would expect by chance (Huelsenbeck and Kirkpatrick 1996, Mooers and Heard 1997). This has lead systematists to conclude, among other things, that effects such as clade selection are prevalent and that phylogenies are not just the result of random branching. What we would expect “by chance” is (appropriately) determined by examining a Yule distribution, but the published phylogenies typically do not use prior probabilities and if they do, they use a uniform distribution which is skewed toward asymmetry relative to the Yule distribution. Since the Yule process represents random branching, the use of uniform priors on topologies (or the use of no priors at all) have biased the results in favor of more asymmetric trees. In other words, we should expect the result that published phylogenies are more

asymmetric than expected by the Yule process. By thinking about the base-rate fallacy, we can see that if our data leads us to conclude that a tree is unbalanced, this might be a case where it is more probable that the tree is more balanced, but that the data is misleading. Of course not every case will be a false positive, effects such as clade selection and taxa sampling bias certainly do affect inferred tree shapes, but the above analysis points to an important project that still needs to be done – reexamining the data on tree shapes to see just how much of the apparent difference between actual history and randomly produced trees is simply an artifact of getting the history wrong in the first place due to ignoring the process by which trees are generated.

References

- Aldous, D. J. (2001). Stochastic models and descriptive statistics for phylogenetic trees, from Yule to today. *Statistical Science*, 16(1), 23-34.
- Andersson J., Sjögren, Å., Davis, L., Embley, T., Roger, A. (2003). Phylogenetic analyses of diplomonad genes reveal frequent lateral gene transfers affecting eukaryotes. *Current Biology*, 13(2), 94-104.
- Avise, J. C. & Ball, R. M. (1990). Principles of genealogical concordance in species concepts and biological taxonomy. *Oxford Surveys in Evolutionary Biology*, 7, 45–67.
- Avise, J. C., & Johns, G. C. (1999). Proposal for a standardized temporal scheme of biological classification for extant species. *Proceedings of the National Academy of Sciences of the United States of America*, 96(13), 7358-7363.
- Avise, J. C. & Mitchell, D. (2007). Time to standardize taxonomies. *Systematic Biology*, 56, 130-133.
- Ayala, F. J. & Escalante, A. E. (1996). The evolution of human populations: A molecular perspective. *Molecular Phylogenetics and Evolution* 5(1), 188–201.
- Baptiste, E., Boucher, Y., Leigh, J., Doolittle, W. F. (2004). Phylogenetic reconstruction and lateral gene transfer. *Trends in Microbiology*, 12, 406-411.
- Barker, M. J. (2005). *Species of Biology: The Cohesion and Individuality of Biological Species*. M.A. Thesis, University of Alberta.

- Barker, M. J., (in press). The empirical inadequacy of species cohesion by gene flow, *Philosophy of Science*.
- Barker, M. J. and Wilson, R. A. (submitted), Flowing genes and cohesive species.
- Baum, D. A. (1992). Phylogenetic species concepts. *Trends in Ecology & Evolution*, 7(1), 1-2.
- Baum, D. A. (1998). Individuality and the existence of species through time. *Systematic Biology*, 47(4), 641-653.
- Baum, D.A. (2007). Concordance trees, concordance factors, and the exploration of reticulate genealogy. *Taxon* 56(2), 417–426.
- Baum, D.A. (manuscript). *Tree-Thinking: Phylogenetic Trees and Their Importance*.
- Baum, D. A., & Donoghue, M. J. (1995). Choosing among alternative "phylogenetic" species concepts. *Systematic Botany*, 20(4), 560-573.
- Baum, D. A. & Shaw, K. L. (1995). Genealogical perspectives on the species problem. In P. C. Hoch & A. G. Stephenson (Eds.), *Experimental and Molecular Approaches to Plant Biosystematics* (pp. 289-303). St. Louis, MO: Missouri Botanical Garden.
- Baum, D. A., Smith, S. D., & Donovan, S. S. (2005). The tree-thinking challenge. *Science*, 310, 979-980.
- Berlin, B., (1992). *Ethnobiological Classification*. Princeton, NJ: Princeton University Press.

- Borjesson, G. (1999). Not for their own sake: Species and the riddle of individuality. *Review of Metaphysics*, 52(4): 867-896.
- Brown, J. K. M. (1994). Probabilities of evolutionary trees. *Systematic Biology*, 43(1), 78-91.
- Burma, B.H. (1954). Reality, existence and classification: A discussion of the species problem. In C. N. Slobadchikoff (Ed.) *Concepts of Species* (pp. 193-209). Stroudsburg, PA: Douden, Hutchinson & Ross.
- Boyd, R. N. (1999). Homeostasis, species, and higher taxa. In: R. A. Wilson (Ed.) *Species: new interdisciplinary essays* (pp. 141-185). Cambridge, MA: MIT Press.
- Bremer, K., & Wanntorp, H. E. (1979). Geographic populations or biological species in phylogeny reconstruction? *Systematic Zoology*, 28(2), 220-224.
- Brown, J. M., Pellmyr, O., Thompson, J. N., & Harrison, R. G. (1994). Phylogeny of greya (lepidoptera: Prodoxidae), based on nucleotide sequence variation in mitochondrial cytochrome oxidase I and II: Congruence with morphological data. *Molecular Biology and Evolution*, 11(1), 128-141.
- Brummitt, R. K. (1996). In defense of paraphyletic taxa. In Maesen, L.J.G. van der, Burgt, X.M. van der & Medenbach de Rooy, J.M. van (Eds.), *The biodiversity of African plants. Proceedings XIVth AETFAT Congress 22-27 August 1994 Wageningen, the Netherlands* (pp. 371-384). Dordrecht.

- Brummitt, R. K. (1997). Taxonomy versus cladonomy, a fundamental controversy in biological systematics. *Taxon*, 46(4), 723-734.
- Brummitt, R. K. & Sosef, M. S. M. (1998). Paraphyletic taxa are inherent in Linnaean classification—a reply to Freudenstein. *Taxon*, 47, 411–412.
- Centers for Disease Control and Prevention. *HIV/AIDS Surveillance Report, 2005*. Vol 17. Atlanta: U.S. Department of Health and Human Services, Centers for Disease Control and Prevention; 2006:1-54. Also available at <http://www.cdc.gov/hiv/topics/surveillance/resources/reports/2005report/>.
- Chang, J. T. (1999). Recent common ancestors of all present-day individuals. *Advances in Applied Probability*, 31, 1002-1026.
- Ciccarelli, F. D., Doerks, T., von Mering, C., Creevey, C. J., Snel, B., Bork, P. (2006). Toward automatic reconstruction of a highly resolved tree of life. *Science*, 311(5765), 1283-1287.
- Coyne, J. A., & Orr, H. A. (2004). *Speciation*. Sinauer Associates.
- Cracraft, J. (1983). Species concepts and speciation analysis. *Current Ornithology*, 1, 159-187.
- Cracraft J. (1997). Species concepts and the ontology of evolution. *Biology and Philosophy*, 2, 329-346.

- Cracraft, J. (2000). Species concepts in theoretical and applied biology: a systematic debate with consequences, In Q. D. Wheeler & N. Platnick (Eds.) *Species Concepts and Phylogenetic Theory* (pp. 17-29). New York: Columbia University Press.
- Crane, J. (2004). On the metaphysics of species. *Philosophy of Science*, 71, 156-173.
- Crisp, M., & Chandler, G. (1996). Paraphyletic species. *Telopea*, 6, 813-844.
- Darwin, C. (1859[1964]). *On the Origin of Species: A Facsimile of the First Edition*. Harvard University Press, Cambridge, Massachusetts.
- Dawkins, R. (2004). *The Ancestor's Tale*. Houghton Mifflin Company, New York.
- de Queiroz, K. (1988). Systematics and the darwinian revolution. *Philosophy of Science*, 55(2), 238-259.
- de Queiroz, K. (1998). The general lineage concept of species, species criteria, and the process of speciation: A conceptual unification and terminological recommendations. In D. J. Howard, & S. H. Berlocher, (Eds.) *Endless forms: Species and speciation* (pp. 57-75). New York: Oxford University Press.
- de Queiroz, K. (1999). The general lineage concept of species and the defining properties of the species category. In R. A. Wilson (Ed.) *Species: New interdisciplinary essays* (pp. 49-89). Cambridge, Massachusetts: MIT Press.

- de Queiroz, K. (2005a). Ernst Mayr and the modern concept of species. *Proceedings of the National Academy of Sciences of the United States of America*, 102(Systematics and the Origin of Species: On Ernst Mayr's 100th Anniversary), 6600-6607.
- de Queiroz, K. (2005b). A unified concept of species and its consequences for the future of taxonomy. *Proceedings of the California Academy of Sciences*, 56,196–215.
- de Queiroz, K. (2005c). Different species problems and their resolution. *BioEssays*, 27, 1263–1269.
- de Quieroz, K. & Donoghue, M. (1988). Phylogenetic systematics and the species problem. *Cladistics*, 4, 317-338.
- de Quieroz, K. & Gauthier, J. (1992). Phylogenetic taxonomy. *Annual Review of Ecology and Systematics*, 23, 449-480.
- Diamond, J. M. (1992). *The Third Chimpanzee: The Evolution and Future of the Human Animal*. HarperCollins, New York.
- Donoghue, M. J. (1985). A critique of the biological species concept and recommendations for a phylogenetic alternative. *The Bryologist*, 88(3), 172-181.
- Doolittle, W. F. (1999). Phylogenetic classification and the universal tree. *Science*, 284(5423), 2124-2128.
- Doolittle, W. F. (2000). Uprooting the tree of life. *Scientific American*, February 2000.
- Doolittle, W. F., & Bapteste, E. (2007). Pattern pluralism and the Tree of Life hypothesis, *Proceedings of the National Academy of Sciences*, 104(7), 2043-2047.

- Dupré, J. (1993). *The Disorder of Things: Metaphysical Foundations of the Disunity of Science*. Harvard University Press, Cambridge, Massachusetts.
- Dupré, J. (1999). On the impossibility of a monistic account of species. In R. A. Wilson (Ed.), *Species: New Interdisciplinary Essays* (pp. 3-29). Cambridge, MA: MIT Press.
- Dupré, J. (2001). In defence of classification, *Studies in the History and Philosophy of the Biological and Biomedical Sciences*, 32, 203-219.
- Edwards, A. W. F. (1970). Estimation of the branch points of a branching diffusion process. *Journal of the Royal Statistical Society. Series B (Methodological)*, 32(2), 155-174.
- Eldredge, N. & Cracraft, J. (1980). *Phylogenetic patterns and the evolutionary process : Method and theory in comparative biology*. New York: Columbia University Press.
- Eldredge, N. & Gould, S. (1972). Punctuated equilibria, an alternative to phyletic gradualism. In T. Schopf (Ed.), *Models in Paleobiology* (pp. 82-115). Freeman Cooper, San Francisco.
- Ereshefsky, M. (1991). Species, higher taxa, and the units of evolution, *Philosophy of Science*, 58, 84-101.
- Ereshefsky, M. (1992a). *The Units of Evolution: Essays on the Nature of Species*. MIT Press, Cambridge, Massachusetts.

- Ereshefsky, M. (1992b). Eliminative pluralism, *Philosophy of Science*, 59, 671-690.
- Ereshefsky, M. (1997). The evolution of the Linnaean hierarchy, *Philosophy and Biology*, 12, 493-519.
- Ereshefsky, M. (2001). *The Poverty of the Linnaean Hierarchy: A Philosophical Study of Biological Taxonomy*. Cambridge University Press, Cambridge, UK.
- Farris, J. S. (1983). The logical basis of phylogenetic analysis. *Advances in Cladistics*, 2, 7-36.
- Felsenstein, J. (2004). *Inferring phylogenies*. Sunderland, Mass.: Sinauer Associates.
- Figueroa, F., Günther, E., & Klein, J. (1988). MHC polymorphism predating speciation. *Nature (London)*, 335, 265-267.
- Funk, D. J., & Omland, K. E. (2003). Species-level paraphyly and polyphyly: Frequency, causes, and consequences, with insights from animal mitochondrial DNA. *Annual Review of Ecology Evolution and Systematics*, 34(1), 397-423.
- Gayon, J. (1996). The individuality of the species: A Darwinian theory? — from Buffon to Ghiselin, and back to Darwin. *Biology and Philosophy*, 11(2), 215-244.
- Ghiselin, M. T. (1966). On psychologism in the logic of taxonomic controversies. *Systematic Zoology*, 15(3), 207-215.

- Ghiselin, M. T. (1969). *The Triumph of the Darwinian Method*. University of Chicago Press, Chicago.
- Ghiselin, M. T. (1974). A radical solution to the species problem. *Systematic Zoology*, 23(4), 536-544.
- Ghiselin, M. (1987). Species concepts, individuality, and objectivity. *Biology and Philosophy*, 2, 127-143.
- Ghiselin, M. T. (1997). *Metaphysics and the origin of species*. Albany: SUNY
- Goloboff P. A. & Pol, D. (2005). Parsimony and bayesian phylogenetics. pp. 148-159 in *Parsimony, Phylogeny and Genomics*, ed. Victor A. Albert. Oxford, OX ; New York: Oxford University Press
- Gonder, M. K., Oates, J. F., Disotell, T. R., Forstner, M., Morales, J. C., & Melnick, D. J. (1997). A new west African chimpanzee subspecies? *Nature*, 388, 337.
- Goodman, M., Porter, C. A., Czelusniak, J., Page, S. L., Schneider, H., Shoshani, J., Gunnell, G., & Groves, C. P. (1998). *Molecular Phylogenetics and Evolution* 9, 585-598.
- Gould, S. J., (1989). *Wonderful Life: The Burgess Shale and the Nature of History*. W.W. Norton, New York.
- Gould, S. J., (2002). *The Structure of Evolutionary Theory*. Cambridge, MA: Harvard University Press.
- Gregg, J. R. (1950). Taxonomy, language and reality. *American Naturalist*, 84, 419-435.

- Griffiths, P. E. (1999). Squaring the circle: Natural kinds with historical essences. In R.A. Wilson (Ed.), *Species: New Interdisciplinary Essays* (pp. 210-228). Cambridge, MA: MIT Press.
- Groves, C. (1967). Ecology and taxonomy of the gorilla. *Nature*, 213, 890-893.
- Groves, C. (2002). A history of gorilla taxonomy. In A.B. Taylor and M.L. Goldsmith (Eds.), *Gorilla Biology: A Multidisciplinary Perspective*. Cambridge University Press, Cambridge.
- Groves, C. (2004). The what, why and how of primate taxonomy, *International Journal of Primatology*, 25(5), 1105-1126.
- Groves, C. (2005). Primates. In D. E. Wilson, & D. M. Reeder (Eds.), *Mammal Species of the World*, 3rd edition (pp. 111-184). Johns Hopkins University Press.
- Haber, M. H. (2005). On probability and systematics: Possibility, probability, and phylogenetic inference. *Systematic Biology*, 54(5), 831-841.
- Haeckel, E. (1874). *Anthropogenie*. Engelmann, Leipzig.
- Haeckel, E. (1876). *The evolution of man*, [E. Haeckel, tr. from 3rd German edition of *Anthropogenie*]. Werner Company, Akron, Ohio.
- Halliburton, R. (2004). *Introduction to population genetics*. Upper Saddle River, NJ: Pearson/Prentice Hall.

- Harding, E. F. (1971). The probabilities of rooted tree-shapes generated by random bifurcation. *Advances in Applied Probability*, 3(1), 44-77.
- Harrison, R. (1998). Linking evolutionary pattern and process: The relevance of species concepts for the study of speciation. In D. Otte & J. A. Endler, (Eds). *Speciation and its Consequences*, (pp. 19-31). Sunderland, England: Sinauer Associates.
- Hein, J., Schierup, M., Wiuf, C. (2005). *Gene genealogies, variation and evolution : A primer in coalescent theory*. Oxford: New York: Oxford University Press.
- Hennig, W. (1966). *Phylogenetic Systematics*. University of Chicago Press, Chicago.
- Hennig, W. (1969[1981]). *Insect Phylogeny*. Translated by A.C. Pont. John Wiley Press, New York. Originally published as *Die Stammesgeschichte der Insekten*, Waldemar Kramer, Frankfurt.
- Hey, J. (2001). *Genes, Categories, and Species: The Evolutionary and Cognitive Causes of the Species Problem*. Oxford University Press, New York.
- Holsinger, K. (1984). The nature of biological species. *Philosophy of Science*, 51, 293-307.
- Howson, C. & Urbach, P. (2005). *Scientific Reasoning: The Bayesian Approach* (3rd edition). La Salle, Illinois: Open Court.
- Hudson, R. R. (1983). Testing the constant-rate neutral model with protein sequence data. *Evolution*, 37, 203-217.

Huelsenbeck, J. P., & Kirkpatrick, M. (1996). Do phylogenetic methods produce trees with biased shapes? *Evolution*, 50(4), 1418-1424.

Huelsenbeck, J. P., Ronquist, F., Nielsen, R., & Bollback, J. P. (2001). Bayesian inference of phylogeny and its impact on evolutionary biology. *Science (Washington D C)*, 294(5550), 2310-2314.

Huelsenbeck, J. P., & Ronquist, F. (2001). MRBAYES: Bayesian inference of phylogenetic trees. *Bioinformatics (Oxford)*, 17(8), 754-755.

Huelsenbeck, J. P., & Ronquist, F. (2005). Bayesian analysis of molecular evolution using Mr.Bayes. pp. 183-232 in *Statistical Methods in Molecular Evolution*, ed. Rasmus Nielson. New York: Springer.

Hull, D. L. (1968). The operational imperative: sense and nonsense in operationism. *Systematic Zoology*, 17, 438-459.

Hull, D. L. (1974). *The Philosophy of Biological Science*. Prentice-Hall, Englewood Cliffs, New Jersey.

Hull, D. L. (1975). Central subjects and historical narratives. *History and Theory*, 14, 253-274.

Hull, D. L. (1976). Are species really individuals? *Systematic Zoology*, 25, 174-191.

Hull, D. L. (1978). A matter of individuality. *Philosophy of Science*, 45, 335-360.

- Hull, D. L. (1979). The limits of cladism. *Systematic Zoology*, 28, 414-438.
- Hull, D. L. (1980). Individuality and selection. *Annual Review of Ecology and Systematics*, 11, 311-32.
- Hull, D. L. (1988). *Science as Process*. University of Chicago Press, Chicago.
- Huxley, J. S. (1958). Evolutionary processes and taxonomy, with special reference to grades. *Uppsala University Arsskr.* 1958(6), 21-39.
- Joyce, J. (2005). How probabilities reflect evidence. *Philosophical Perspectives*, 19, 153.
- Kadane, J. B. (2006). Is "Objective bayesian analysis" objective, bayesian, or wise? (comment on articles by Berger and by Goldstein). *Bayesian Analysis*, 1(3), 433-436.
- Kingman, J. F. C. (1982). The coalescent. *Stochastic Processes and their Applications*, 13(3), 235-248.
- Kitcher, P. (1984). Species. *Philosophy of Science*, 51, 308-333.
- Kitcher, P. (1987). Ghostly whispers: Mayr, Ghiselin, and the 'philosophers' on the ontological status of species. *Biology and Philosophy*, 2, 184-92.
- Kluge, Arnold G. (2005). What is the rationale for 'Ockham's razor' (a.k.a. parsimony) in phylogenetic inference? In V. A. Albert (Ed.), *Parsimony, Phylogeny and Genomics*, (pp. 15-42). Oxford, OX ; New York: Oxford University Press.

- LaPorte, J. (2005). Is there a single objective, evolutionary tree of life? *The Journal of Philosophy*, 102(7), 357-374.
- LaPorte, J. (2007). In defense of species. *Studies in the History and Philosophy of the Biological and Biomedical Sciences*, 38(1), 255-269.
- Larget, B., & Simon, D. L. (1999). Markov chain monte carlo algorithms for the bayesian analysis of phylogenetic trees. *Molecular Biology and Evolution*, 16(6), 750-759.
- Larget, B. (2005). Introduction to Markov Chain Monte Carlo methods in molecular evolution. In R. Nielson (Ed.), *Statistical Methods in Molecular Evolution* (pp. 44-61). New York: Springer.
- Larson, J. (1971). *Reason and Experience: The Representation of Natural Order in the Work of Carl von Linné*. University of California Press, Berkeley.
- Lawler, D. A., Ward, F. E., Ennis, P. D., Jackson, A. P., Parham, P. (1988). HLA-A and B polymorphisms predate the divergence of humans and chimpanzees. *Nature*, 335, 268-71.
- Lecointre, G. & Le Guyader, H. (2007). *The Tree of Life: A Phylogenetic Classification*. (K. McCoy, Trans.). Belnap Press of Harvard University Press, Cambridge, MA.
- Maddison, W. P. (1995). Phylogenetic histories within and among species. In P. C. Hoch, & A. G. Stephenson (Eds.), *Experimental and Molecular Approaches to Plant Biosystematics* (pp. 273–87). Missouri Botanical Garden, St. Louis. St. Louis, MO).

- Maddison, W. P. (1997). Gene trees in species trees. *Systematic Biology*, 46(3), 523-536.
- Mallet, J. (1995). A species definition for the modern synthesis. *Trends in Ecology & Evolution*, 10, 294-299.
- Martin, G. (1996). Birds in double trouble, *Nature*, 380, 666-667.
- Mayden, R. L. (1997). A hierarchy of species concepts: The denouement in the saga of the species problem. In M. F. Claridge, H. A. Dawah, & M. R. Wilson (Eds.), *Species: The Units of Biodiversity* (pp. 381-424). London: Chapman and Hall.
- Mayr, E. (1942). *Systematics and the origin of species from the viewpoint of a zoologist*. New York: Columbia University Press.
- Mayr, E. (1959). Typological versus population thinking, in *Evolution and Anthropology: A Centennial Appraisal*. The Anthropological Society of Washington, Washington, D.C.
- Mayr, E. (1963). *Animal Species and Evolution*, Cambridge, MA: Harvard University Press.
- Mayr, E. (1969). *Principles of systematic zoology*. New York: McGraw-Hill.
- Mayr, E. (1970). *Populations, Species and Evolution*. Cambridge, MA: Harvard University Press.
- Mayr, E. (1976). *Evolution and the Diversity of Life*. Harvard University Press, Cambridge, Massachusetts.

- Mayr, E. (1982). *The Growth of Biological Thought*. Harvard University Press, Cambridge, Massachusetts.
- Mayr, E. (1997). The objects of selection, *Proceedings of the National Academy of Sciences*, 94, 2091-4.
- Mayr, E. (2000). The biological species concept. In: Q.D. Wheeler & N. Platnick, (Eds). *Species Concepts and Phylogenetic Theory* (pp. 17-29). New York: Columbia University Press.
- Mayr, E. & Ashlock, P. D. (1991). *Principles of systematic zoology* (2nd edition). New York: McGraw-Hill.
- McNeill, J., Barrie, F. R., Burdet, H. M., Demoulin, V., Hawksworth, D. L., Marhold, K., Nicolson, D. H., Prado, J., Silva, P. C., Skog, J. E., Wiersema, J. H. & Turland, N. J. (eds.) 2006. International Code of Botanical Nomenclature (Vienna Code) adopted by the Seventeenth International Botanical Congress Vienna, Austria, July 2005. Gantner Verlag, Ruggell, Liechtenstein.
- Metzker, M. L., Mindell, D. P., Liu, X. M., Ptak, R. G., Gibbs, R. A., & Hillis, D. M. (2002). Molecular evidence of HIV-1 transmission in a criminal case. *Proceedings of the National Academy of Sciences*, 99(22), 14292-14297.
- Mishler, B. D. (1985). The morphological, developmental, and phylogenetic basis of species concepts in bryophytes. *The Bryologist*, 88(3), 207-214.

- Mishler, B. D. (1999). Getting rid of species, in R.A. Wilson (ed.), *Species: New Interdisciplinary Essays*. Cambridge, MA: MIT Press.
- Mishler, B. D. & Theriot, E. C. (2000). The phylogenetic species concept (Sensu Mishler and Theriot). In: Q.D. Wheeler and N. Platnick, eds. *Species Concepts and Phylogenetic Theory*, 44-54. New York: Columbia University Press.
- Mishler, B. D., & Brandon, R. N. (1987). Individuality, pluralism, and the phylogenetic species concept. *Biology and Philosophy*, 2, 397-414.
- Mishler, B. D., & Donoghue, M. J. (1982). Species concepts: A case for pluralism. *Systematic Zoology*, 31(4), 491-503.
- Mooers, A. O., & Heard, S. B. (1997). Inferring evolutionary process from phylogenetic tree shape. *The Quarterly Review of Biology*, 72(1), 31-54.
- Nelson, G. (1979). Cladistic analysis and synthesis: Principles and definitions, with a historical note on Adanson's *Familles des Plantes* (1763-1764). *Systematic Zoology*, 28, 1-21.
- Nelson, G. (1989). Cladistics and evolutionary models. *Cladistics*, 5, 275-289.
- Nelson G. & Platnick, N. (1981). *Systematics and Biogeography: Cladistics and Vicariance*. Cambridge University Press, New York.
- Nixon, K., & Wheeler, Q. (1990). An amplification of the phylogenetic species concept. *Cladistics*, 6(3), 211-223.

- O'Hara, R. J. (1997). Population thinking and tree thinking in systematics. *Zoologica Scripta*, 26(4), 323-329.
- O'Hara, R. J., (1988). Homage to Clio, or, toward an historical philosophy for evolutionary biology. *Systematic Zoology*, 37(2), 142-155.
- Owen, R. (1858). On the characters, principles of division and primary groups of the Mammalia. *Journal of the Proceedings of the Linnean Society (Zoology)*, 2, 1-37.
- Palca, J. (1992). CDC Closes the Case of The Florida Dentist. *Science*, 256, 1130-1131.
- Pigliucci, M. (2003). Species as family resemblance concepts: The (dis-)solution of the species problem? *BioEssays*, 25(6), 596-602.
- Pigliucci, M. & Kaplan, J. (2006). *Making sense of evolution : The conceptual foundations of evolutionary biology*. Chicago: University of Chicago Press.
- Pickett, K. M., & Randle, C. P. (2005). Strange bayes indeed: Uniform topological priors imply non-uniform clade priors. *Molecular Phylogenetics and Evolution*, 34(1), 203-211.
- Pitnick, S., Jones, K. E., & Wilkinson, G. S. (2006). Mating system and brain size in bats. *Proceedings of the Royal Society Biological Sciences Series B*, 273(1587), 719-724.

- Poux, C., Madsen, O., Marquard, E., Vieites, D. R., de Jong, W. W., & Vences, M. (2005). Asynchronous colonization of madagascar by the four endemic clades of primates, tenrecs, carnivores, and rodents as inferred from nuclear genes. *Systematic Biology*, 54(5), 719-730.
- Randle, C. P., Mort, M. E., & Crawford, D. J. (2005). Bayesian inference of phylogenetics revisited: Developments and concerns. *Taxon*, 54(1), 9-15.
- Rannala, B., & Yang, Z. (1996). Probability distribution of molecular evolutionary trees: A new method of phylogenetic inference. *Journal of Molecular Evolution*, 43(3), 304-311.
- Rieppel, O., (2007). Species: Kinds of individuals or individuals of a kind”, *Cladistics*, 23, 373–384.
- Rieseberg, L. H., & Brouillet, L. (1994). Are many plant species paraphyletic? *Taxon*, 43(1), 21-32.
- Rohde, D.L.T., Olson, S., and Chang, J.T. (2004). Modelling the recent common ancestry of all living humans, *Nature*, 431(7008), 562-6.
- Rohde, D.L.T. (submitted). *On the common ancestors of all living humans*. Submitted to American Journal of Physical Anthropology.
- Rosen, D. E. (1978). Vicariant patterns and historical explanation in biogeography. *Systematic Zoology*, 27(2), 159-188.

- Rosenberg, A. (1985). *The Structure of Biological Science*. Cambridge University Press, Cambridge.
- Ruse, M. (2005). *The Evolution-Creation Struggle*. Harvard University Press, Cambridge, Massachusetts.
- Sandvik, H. (2008) Anthropocentricisms in cladograms. *Biology and Philosophy*, 23, in press.
- Scott, J. A. (1995). *The Butterflies of North America*. Stanford University Press, Stanford.
- Semple, C., & Steel, M. (2003). *Phylogenetics*. Oxford ; New York: Oxford University Press.
- Shaw, K. L. (2001). The genealogical view of speciation. *Journal of Evolutionary Biology*, 14, 880-882.
- Siddall, M. E., & Kluge, A. G. (1997). Probabilism and phylogenetic inference. *Cladistics*, 13(4), 313-336.
- Simpson, G. (1961). *The Principles of Animal Taxonomy*. Columbia University Press, New York.
- Smith, T. F. & Waterman, M. S. (1992). The Continuing Case of the Florida Dentist. *Science*, 256, 1155-1156.
- Sneath, P. H. A. & Sokal, R. R. (1973). *Numerical taxonomy; the principles and practice of numerical classification*. San Francisco: W. H. Freeman.

- Sober, E. (1980). Evolution, population thinking, and essentialism, *Philosophy of Science* 47(3), 350-383.
- Sober, E. (1988). *Reconstructing the Past. Parsimony, Evolution, and Inference*. MIT Press, Cambridge, Massachusetts.
- Sober, E. (1993). *Philosophy of Biology*. Westview, Boulder, Colorado.
- Sosef, M. S. M. (1997). Hierarchical models, reticulate evolution and the inevitability of paraphyletic supraspecific taxa. *Taxon*, 46(1), 75-85.
- Stamos, D. N. (1998). Buffon, Darwin, and the non-individuality of species—A reply to Gayon. *Biology and Philosophy*, 13, 443-470.
- Stanford, K. (1995). For pluralism and against realism about species. *Philosophy of Science*, 62, 70-91.
- Steel, M., & McKenzie, A. (2001). Properties of phylogenetic trees generated by Yule-type speciation models. *Mathematical Biosciences*, 170(1), 91-112.
- Sterelny, K. (1999). Species as ecological mosaics. In R. A. Wilson (Ed.), *Species: New Interdisciplinary Essays* (pp. 119-138). Cambridge, MA: MIT Press.
- Susko, E., Leigh, J., Doolittle, W. F. and Baptiste, E. (2006). Visualizing and assessing phylogenetic congruence of core gene sets: a case study of the (gamma)-proteobacteria. *Molecular Biology and Evolution*, 23, 1019-1030.
- Tajima, F. (1983). Evolutionary relationship of DNA sequences in finite populations. *Genetics*, 105, 437-460.

- Tateno , Y., Nei, M., and Tajima, F. (1982). Accuracy of estimated phylogenetic trees from molecular data. I. Distantly related species. *Journal of Molecular Evolution*, 18, 387-404.
- Templeton, A. R. (1989). The meaning of species and speciation: A genetic perspective. In D. Otte & J. A. Endler (Eds). *Speciation and its Consequences* (pp. 3-27). Sunderland, England: Sinauer Associates.
- Templeton, A. R. (2002). Out of Africa again and again. *Nature*, 416, 45-51.
- Thompson, E. A. (1975). *Human evolutionary trees*. Cambridge Eng. ; New York: Cambridge University Press.
- Van Valen, L. (1976). Ecological species, multispecies, and oaks. *Taxon*, 25(2/3), 233-239.
- Velasco, J. D. (2007). Why non-uniform priors on clades are both unavoidable and unobjectionable. *Molecular Phylogenetics & Evolution*, 45, 748–749.
- Watson, E., Esté, S. & Penny, D. (2001). *Homo* genus: a review of the classification of humans and the great apes. In P. V. Tobias, M. A. Raath, J. Moggi-Cecchi & G. A. Doyle (Eds.) *Humanity from African naissance to coming millennia* (pp. 307–318). Firenze University Press and Witwatersrand University Press, Firenze.
- Wheeler, Q. D & Platnick, N. (2000). The phylogenetic species concept (Sensu Wheeler and Platnick). In Q. D. Wheeler and N. Platnick (Eds). *Species Concepts and Phylogenetic Theory* (pp. 55-69). New York: Columbia University Press.

Wiley, E. (1981). *Phylogenetics: The theory and practice of phylogenetic systematics*.

New York: Wiley-Interscience.

Williams, M. (1985). Species are individuals: theoretical foundations for the claim.

Philosophy of Science, 52, 578-90.

Wilson, A. C., Cann, R. L., Carr, S. M., George, M., Jr., Gyllensten, U. B., Helm-

Bychowski, K. M., Higuchi, R. G., Palumbi, S. R., Prager, E.M., Sage, R. D.,

Stoneking, M. (1985). Mitochondrial DNA and two perspectives on evolutionary genetics. *Biological Journal of the Linnean Society*, 26(4), 375-400.

Wilson, R. A. (1999). Realism, essence, and kind. In R.A. Wilson (Ed.), *Species: new*

interdisciplinary essays (pp. 187-207). Cambridge, MA: MIT Press.

Wilson, R. A. (2005). *Genes and the Agents of Life: The Individual in the Fragile*

Sciences: Biology. New York, NY: Cambridge University Press.

Wilson, R. A. (2007). The biological notion of individual. In E.N. Zalta (Ed.), *The*

Stanford Encyclopedia of Philosophy (Fall 2007 Edition).

<http://plato.stanford.edu/archives/fall2007/entries/biology-individual/>

Wilson, R. A., Barker, M. J., & Brigandt, I. (forthcoming). When traditional essentialism

fails: Biological natural kinds.

Woese, C. R., Kandler, O. and Wheelis, M. L. (2000). Towards a natural system of

organisms: Proposal for the domains Archaea, Bacteria, and Eucarya.

Proceedings of the National Academy of Sciences, 87, 4576-4579.

Yang, Z. (2006). *Computational molecular evolution*. Oxford ; New York: Oxford University Press.

Yang, Z., & Rannala, B. (1997). Bayesian phylogenetic inference using DNA sequences: A Markov chain Monte Carlo method. *Molecular Biology and Evolution*, 14(7), 717-724.

Yule, G. U. (1925). A mathematical theory of evolution, based on the conclusions of Dr. JC Willis, FRS. *Philosophical Transactions of the Royal Society of London. Series B*, 213, 21-87.